

Instructions
Notice de montage
Bauanleitung
Istruzioni di montaggio
Instrucciones de montaje
Instruções de montagem
Monteringsanvisning
Kokoamisohje
Monteringsinstruktioner
Montagehandleiding
Οδηγίες συναρμολόγησης.



CONSTRUCTION



- Ⓜ Merci d'imprimer échelle 1 sans les marges de l'imprimante.
- Ⓜ Please print scale 1 without the printer margins.
- Ⓜ Den Mallstab 1 bitte randlos drucken.
- Ⓜ Stampare la scala 1 senza i margini della stampante.
- Ⓜ Imprimir a escala 1 sin los márgenes de la impresora.
- Ⓜ É favor imprimir escala 1 sem as margens de impressão.
- Ⓜ Skriv ut i skala 1 utan skivarens marginaler.
- Ⓜ Po laiden painatuksen jälkeen reunat eivät saa näkyä.
- Ⓜ Uidakivi verligt i målestokkeforhold 1 uden printermargener.
- Ⓜ É favor imprimir escala 1 sem as margens da impressora.
- Ⓜ Σας παρακαλώ τυπώστε την κλίμακα 1 μόνο στις περιφέρειες του εκτυπωτή.

5-8

0302



WARNING : CHOKING HAZARD —
Small parts. Not for children under 3 years.

3
MODELS



+3
MODELS



www.meccano.com

www.meccano.fr

www.meccanouk.co.uk

www.erecator-sets.com

CONSTRUCTION TIPS

LES ASTUCES DE CONSTRUCTION
KONSTRUKTIONSTIPPS
LE ASTUZIE DELLA COSTRUZIONE
LOS INGENIOS DE LA CONSTRUCCIÓN
DICAS PARA A MONTAGEM
KOKOONPANON KIKAT
BYGGKNEPEN
ET PAR TIPS TIL BYGGEARBEJDET
DE FINE KNEEPJES VAN HET BOUWEN
Τα έξυπνα κόλπα κατασκευής





B715 X2



A031(J0031) X2



A456(J0221) X1



A922(J0922) X2



A531(J0031) X2



A622(J0622) X2



A003(J0003) X2



B716 X2



A002(J0002) X2



A057(J0057) X2



A077(J0077) X2



A005(J0005) X2



A312(J0312) X1



A142(J0142R) X4



A046(J0046) X4



A132(J0132) X4



A054(J0054) X1



A051(J0051) X5



C512 X10



A052(J0052) X5



C511 X10



A053(J0053) X4



A545(J0153) X2



B031 X3



A090(MJX0200) X1



Easy Building : Assemble the screw with the nut in just a click!
Also includes the classic Meccano screws and nuts.

Construction facile : La vis et le boulon s'assemblent en un clic!
Contient également des vis et écrous classiques Meccano.

Einfache Konstruktion: Schraube und Mutter einfach ineinanderklicken!
Enthält ebenfalls Standard-Schrauben und Muttern von Meccano.

Fácil de construir: ¡El tornillo y la tuerca encajan en un clic!
Contiene también los clásicos tornillos y tuercas de Meccano.

Eenvoudige constructie: schroef en moer worden gemonteerd in één klik!
Bevat ook klassieke schroeven en moeren van Meccano.



1



2

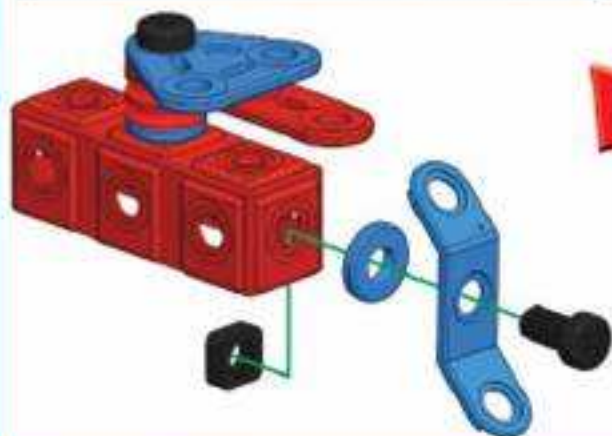

3



4

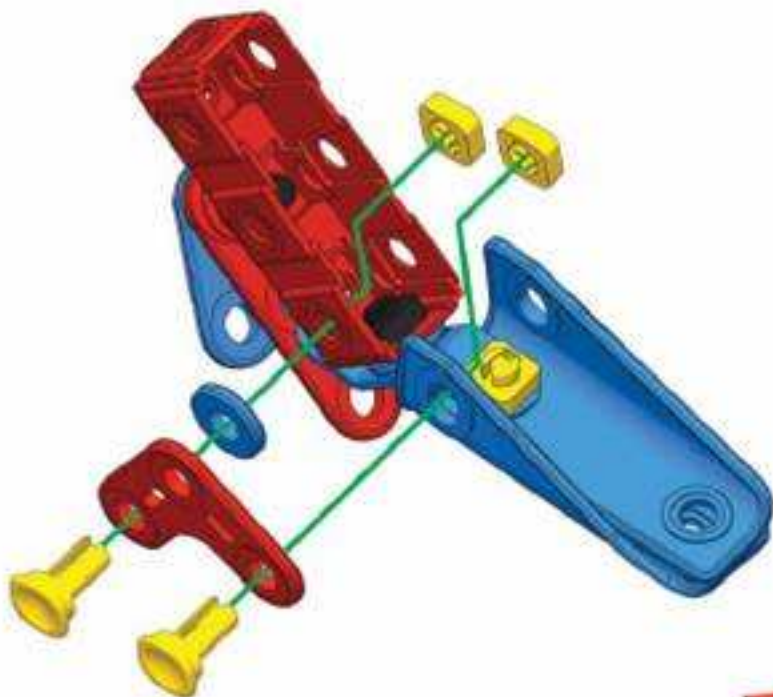

5

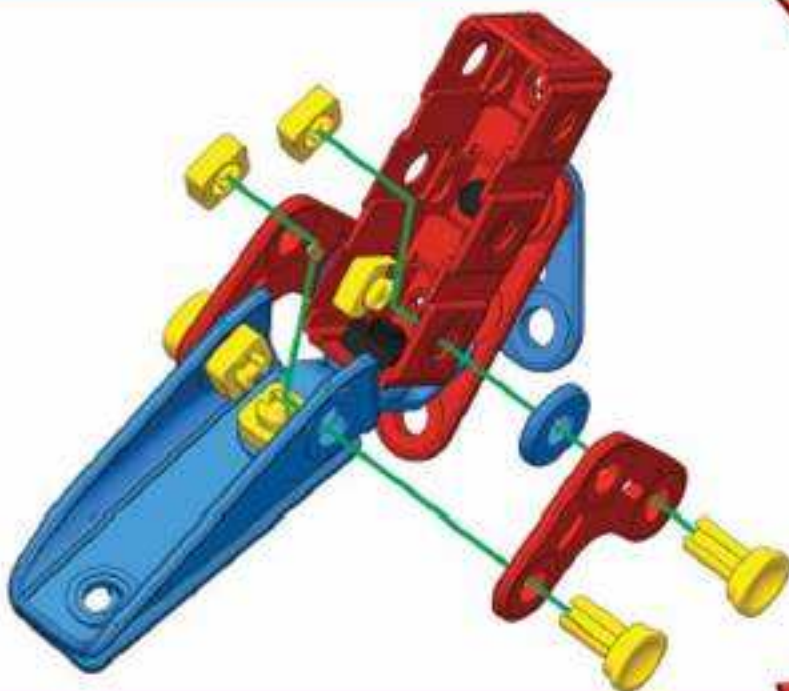

6



7

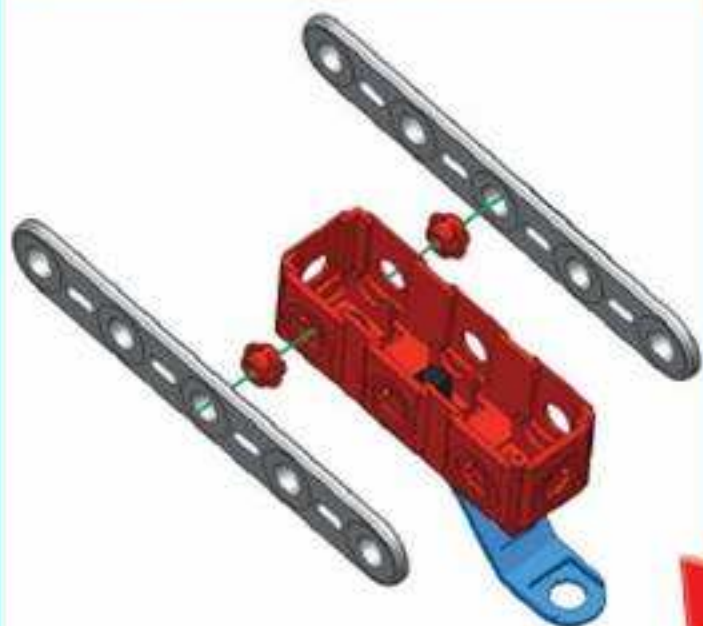

8

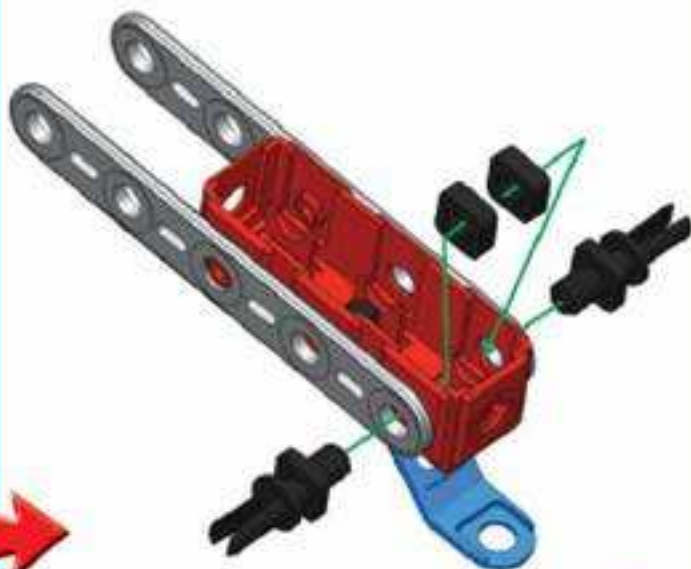

9

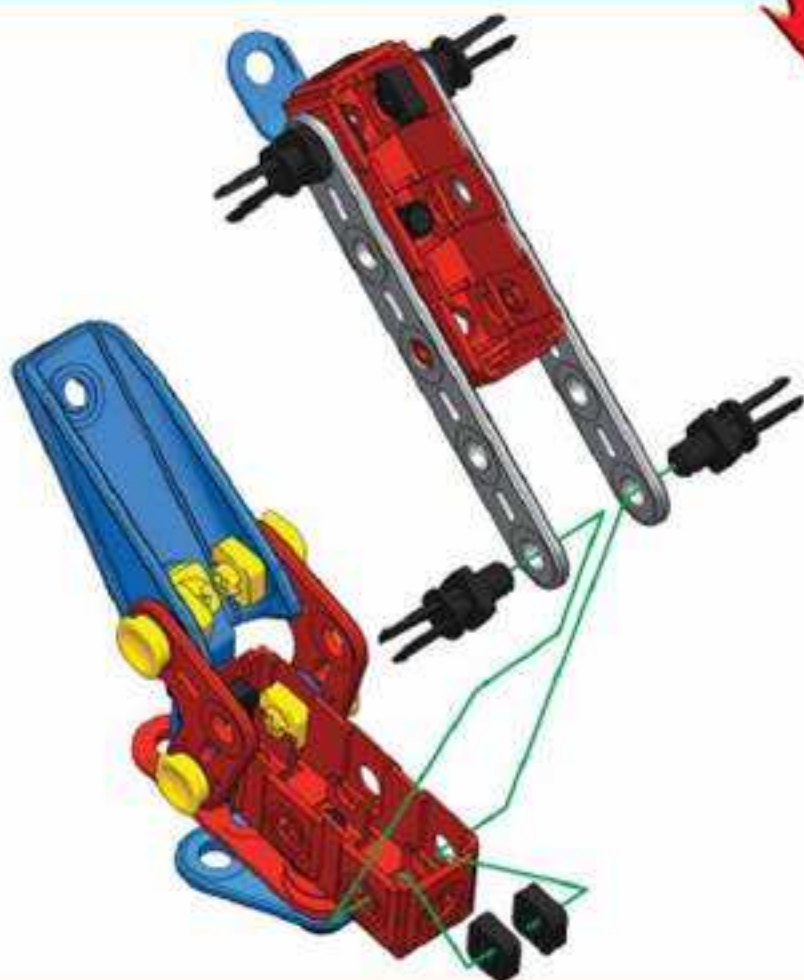

10

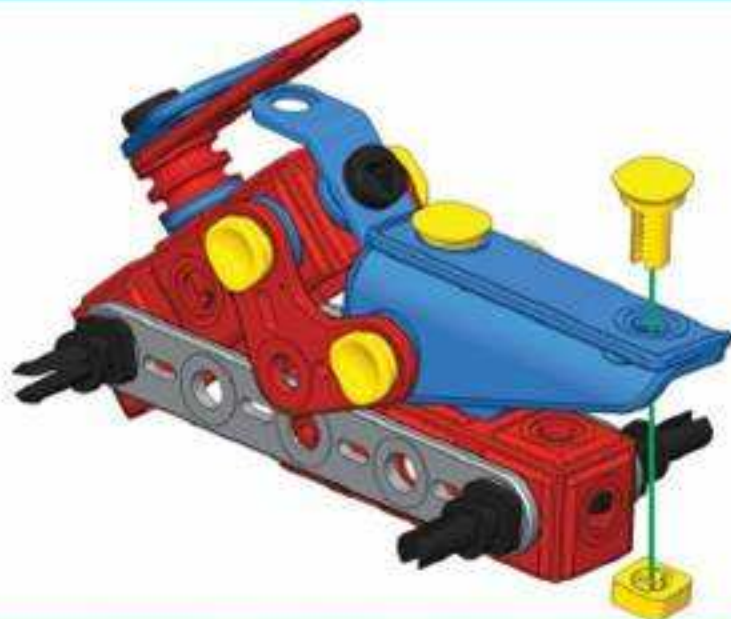

11

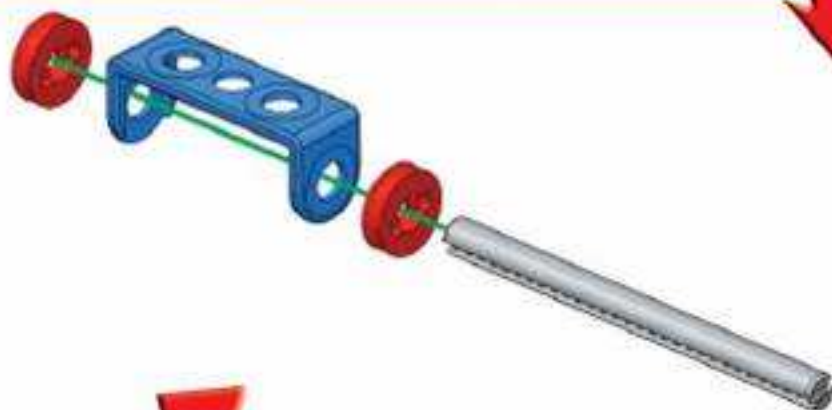

12

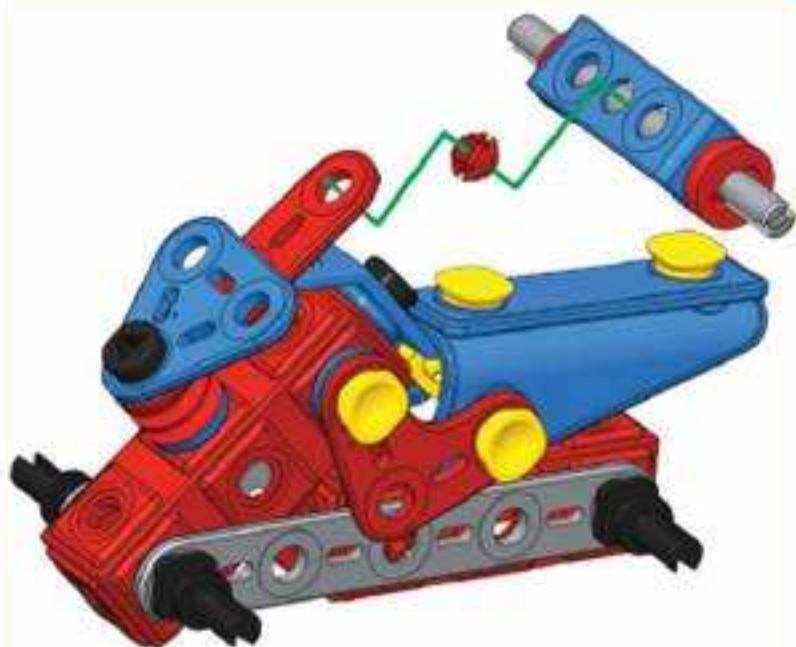

13



x4



14

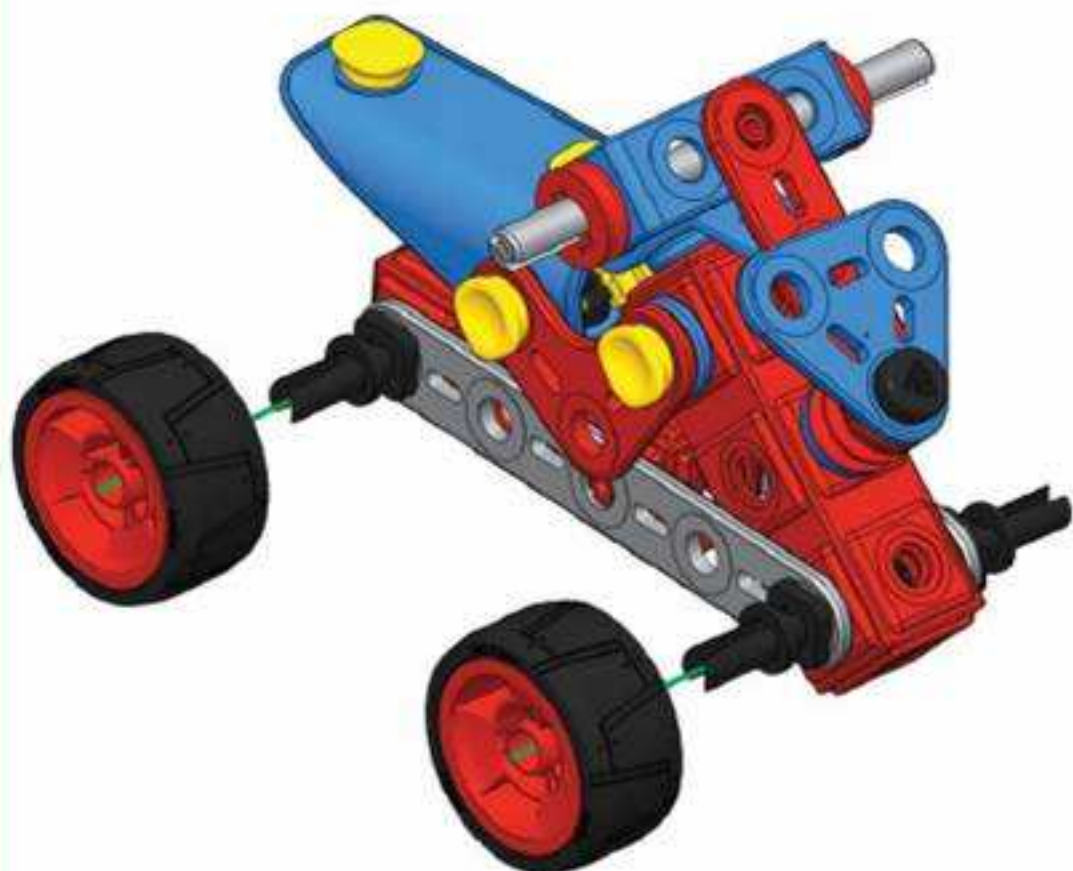

15

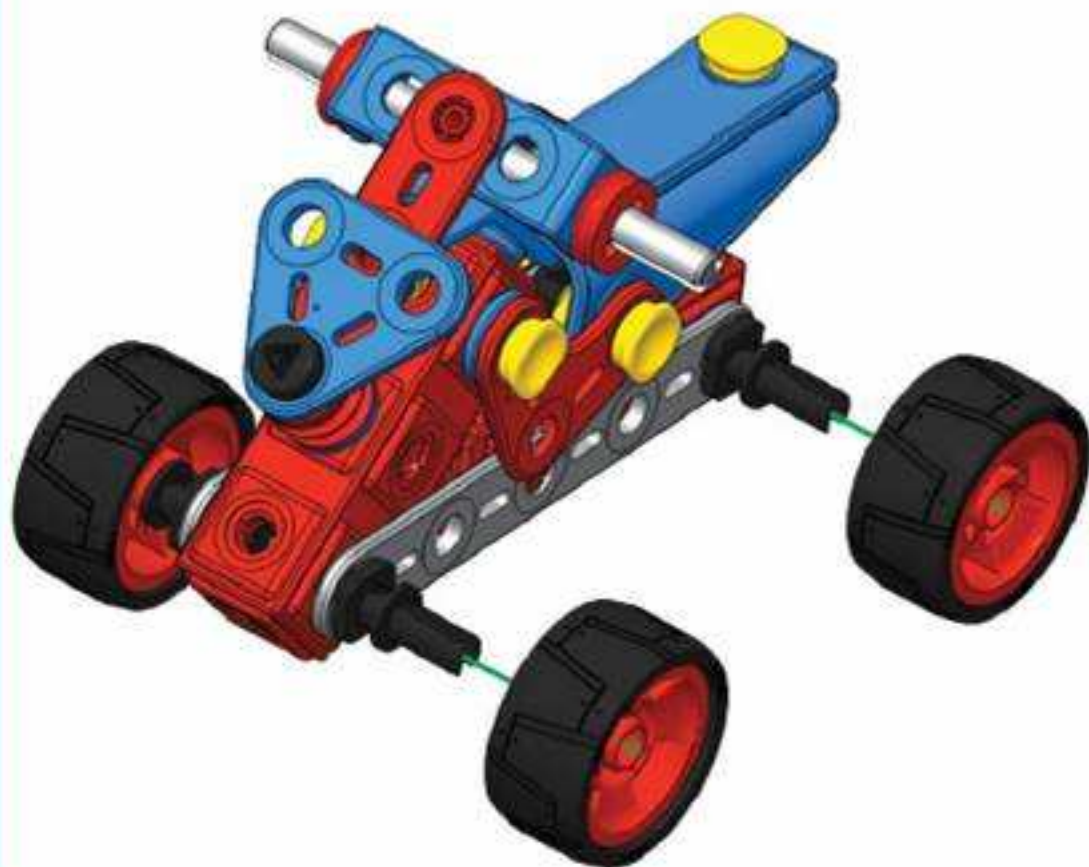

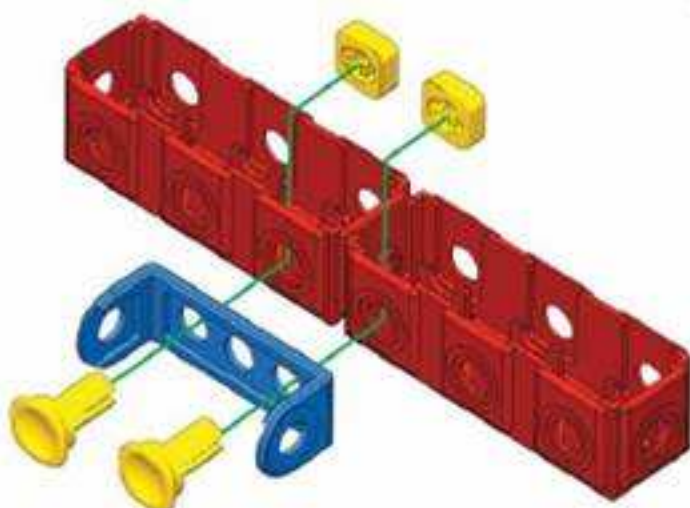
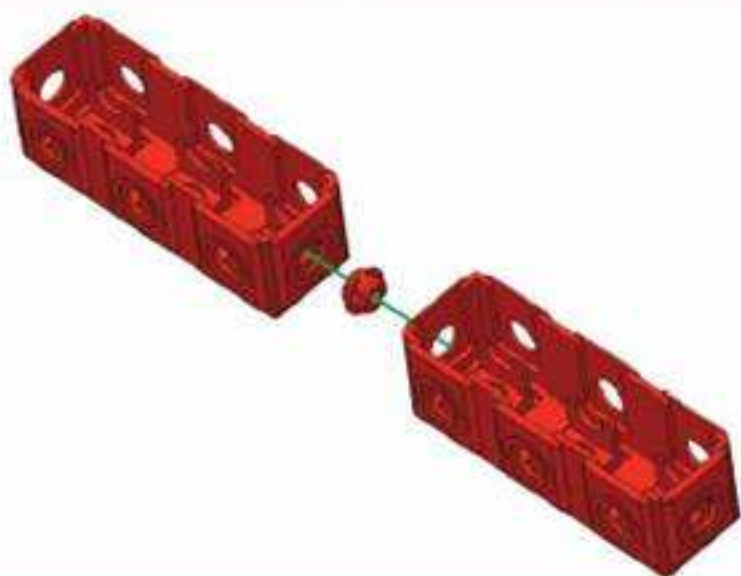

3

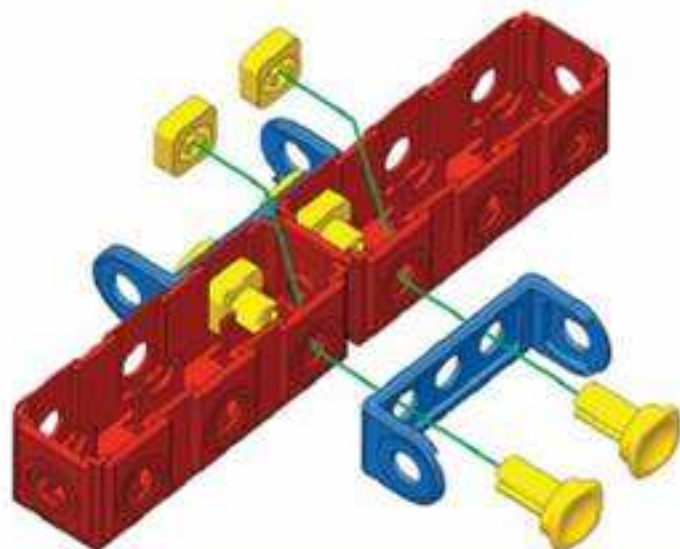

4

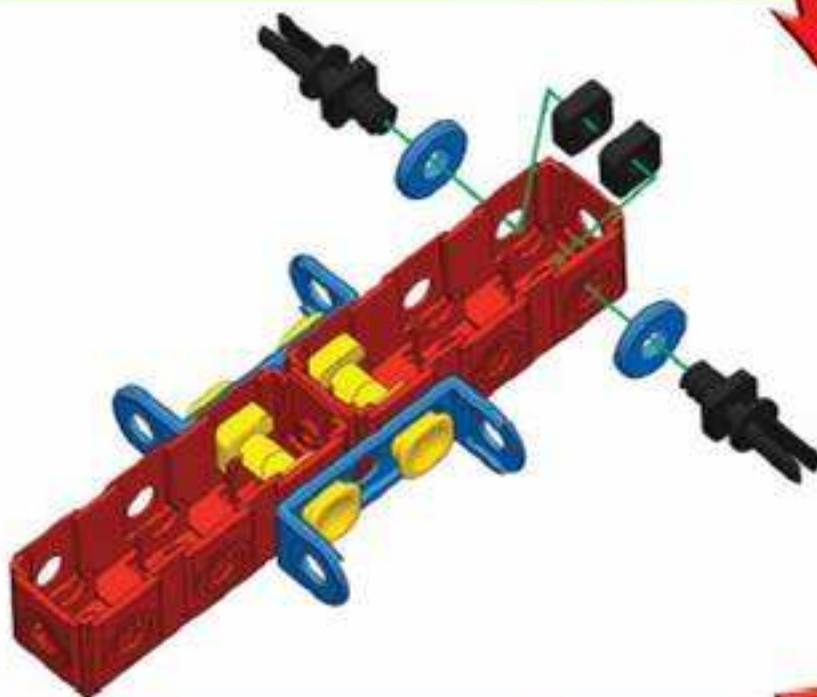

5

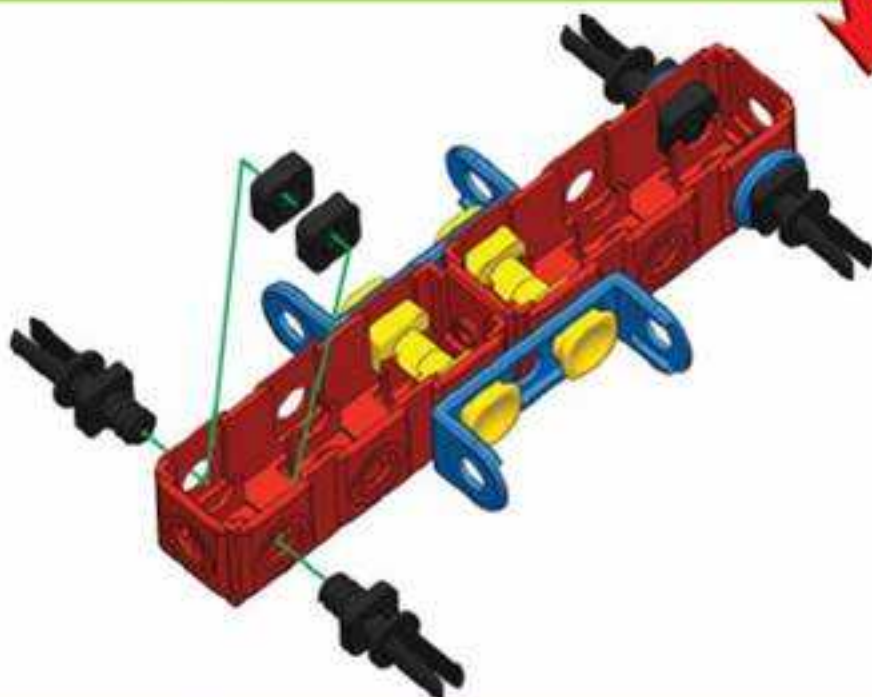

6

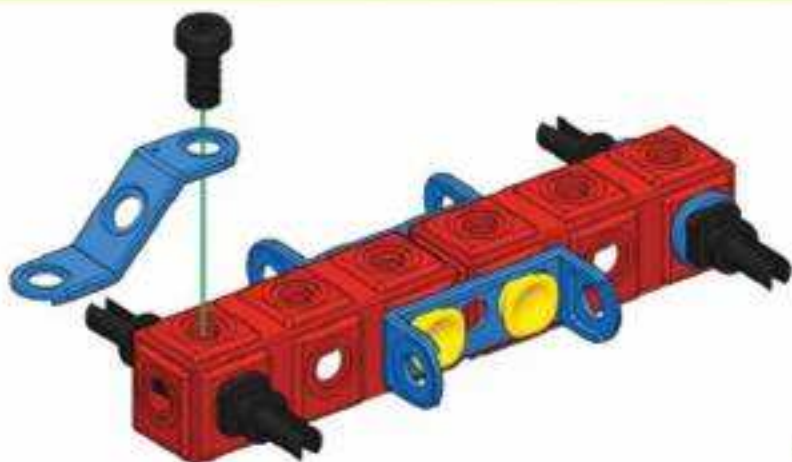

7

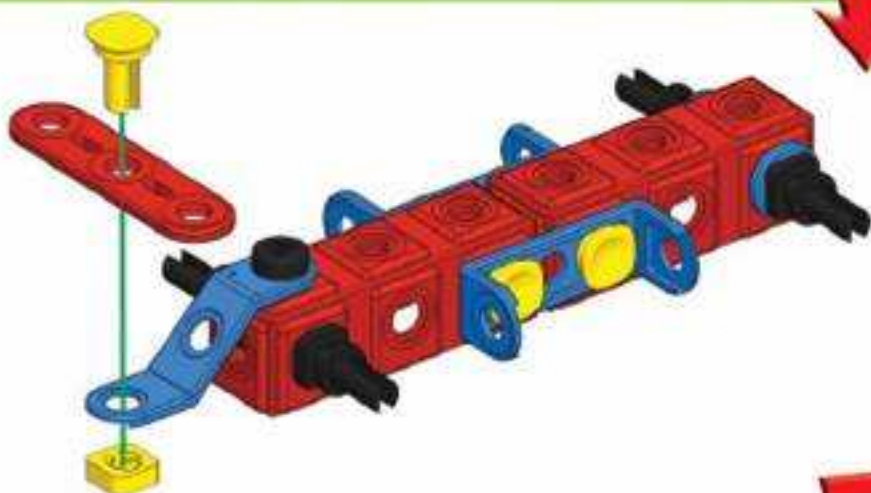

8



9



10



11

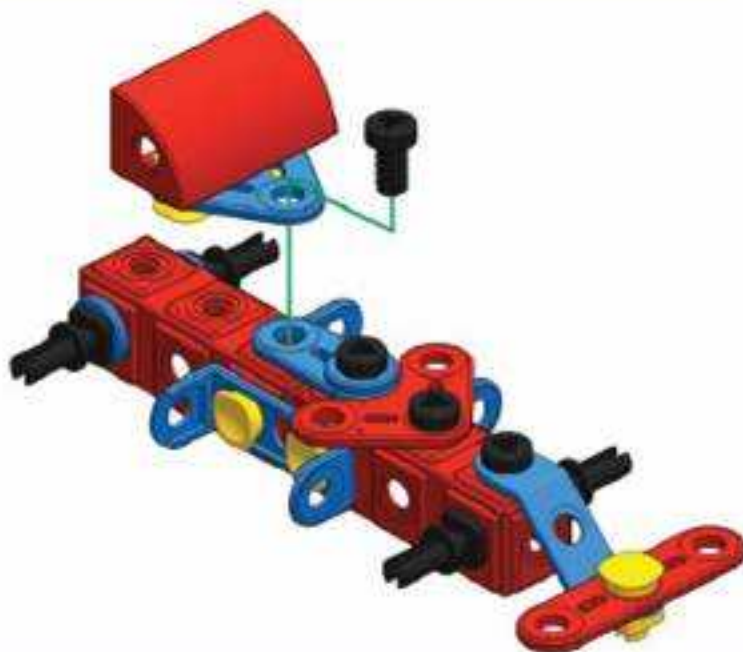

12



13



x4



x4



x4



14



15





1

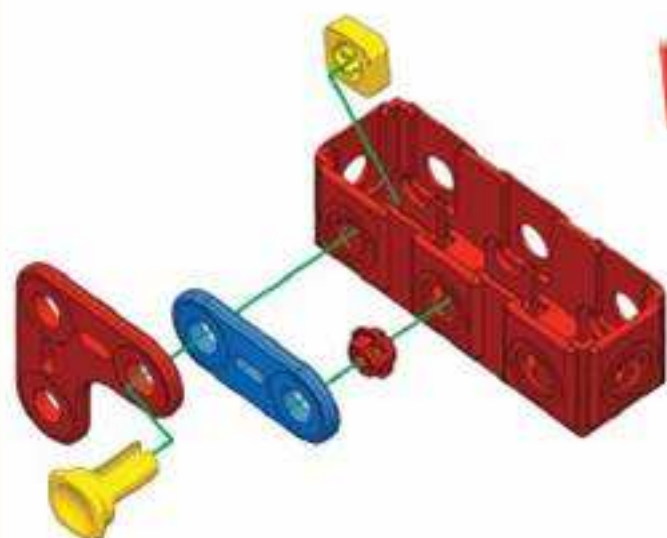

2

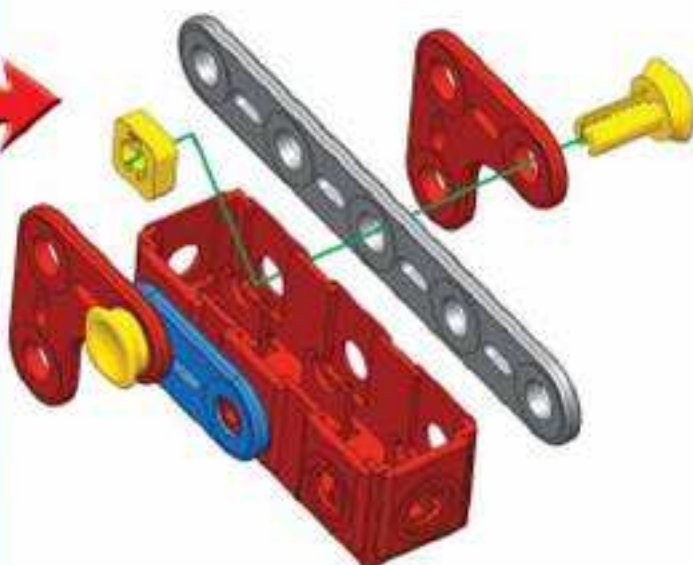

3

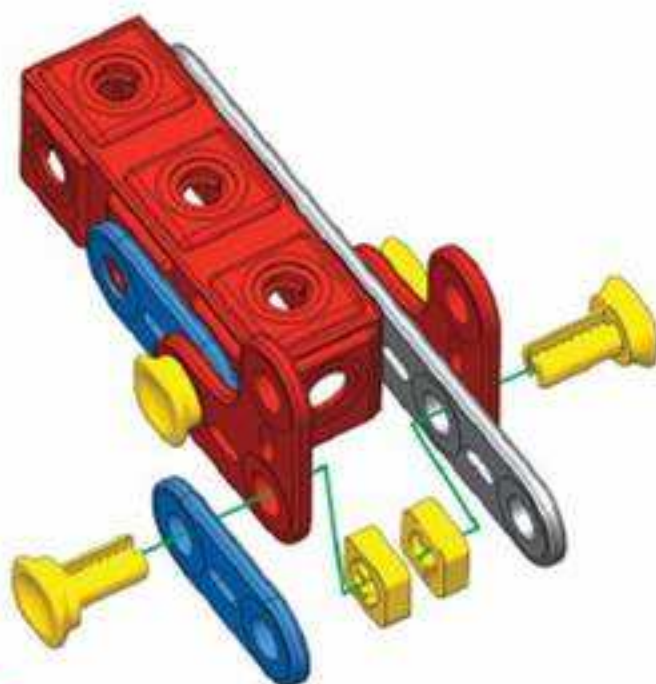

4

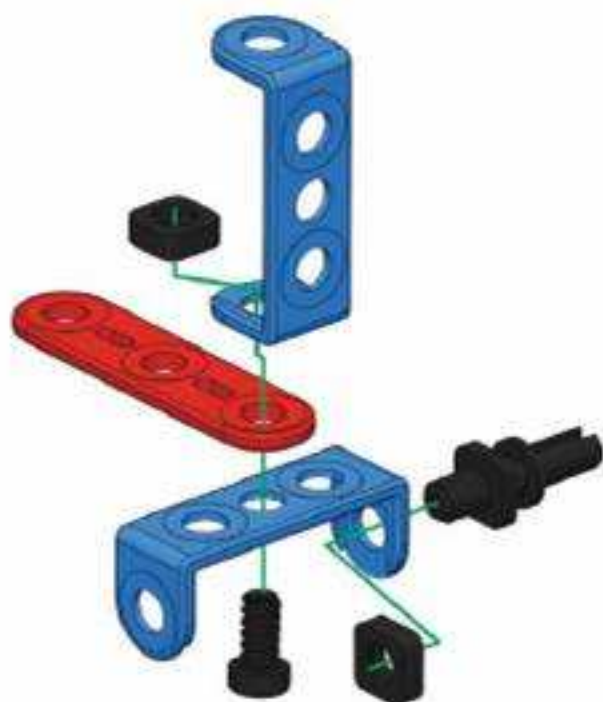

5

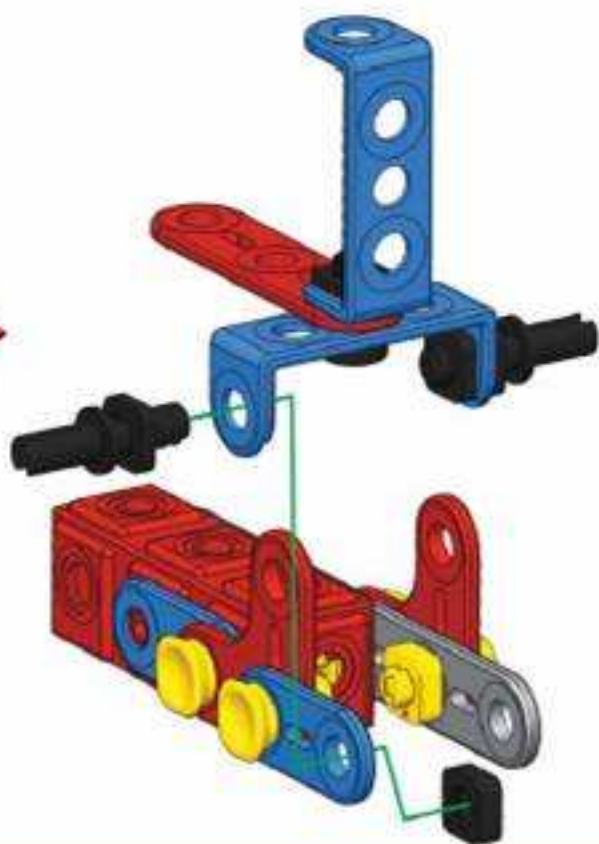

6

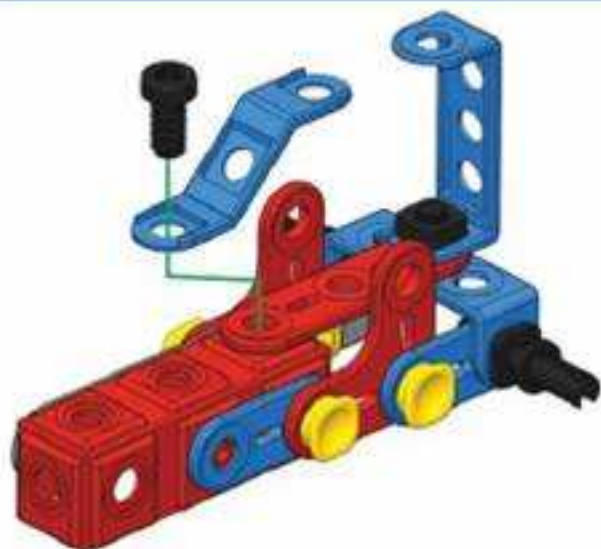

7



8



9



10



11

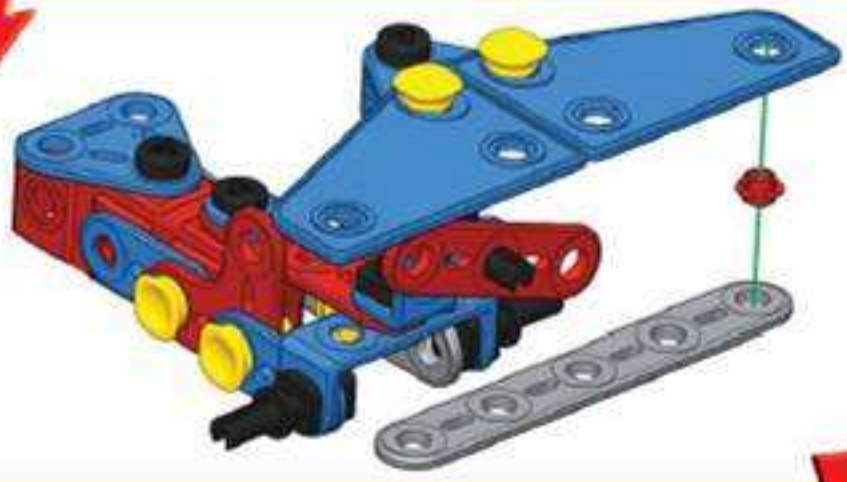

12

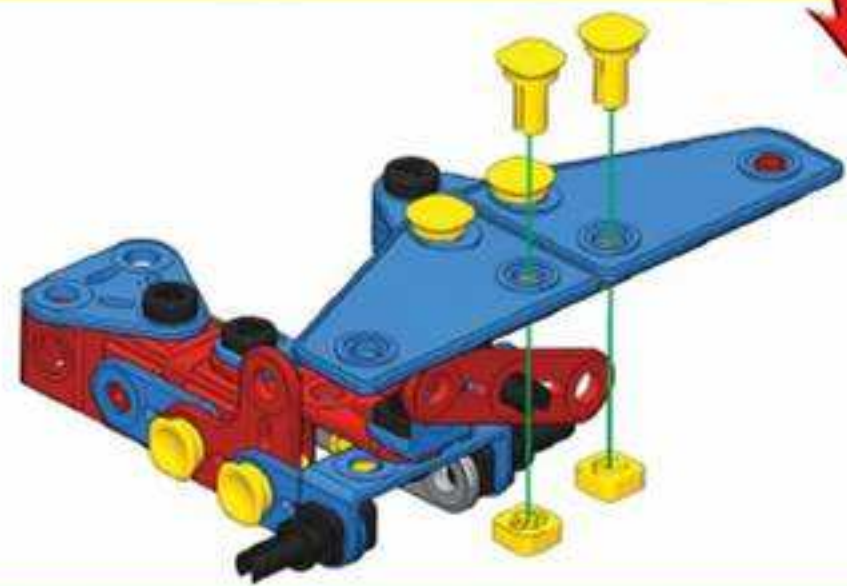

13



14



15





1

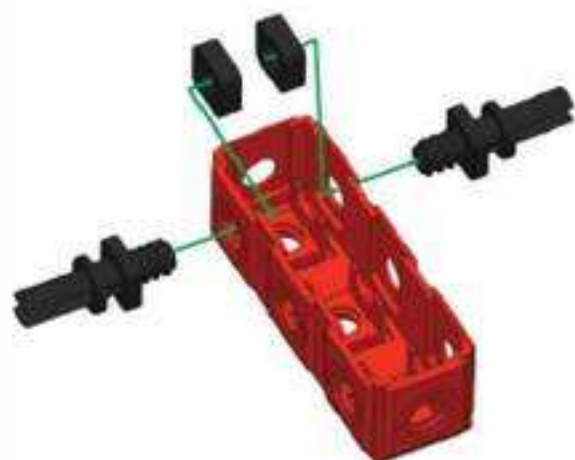
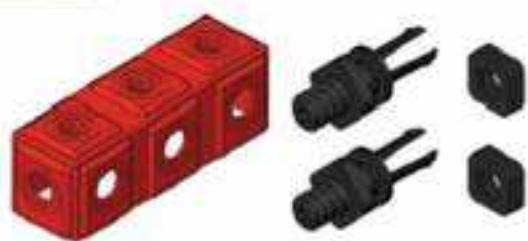

2

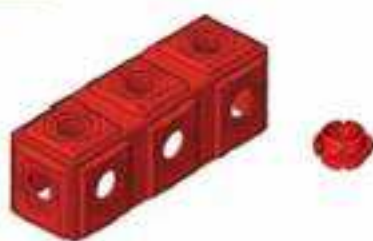

3

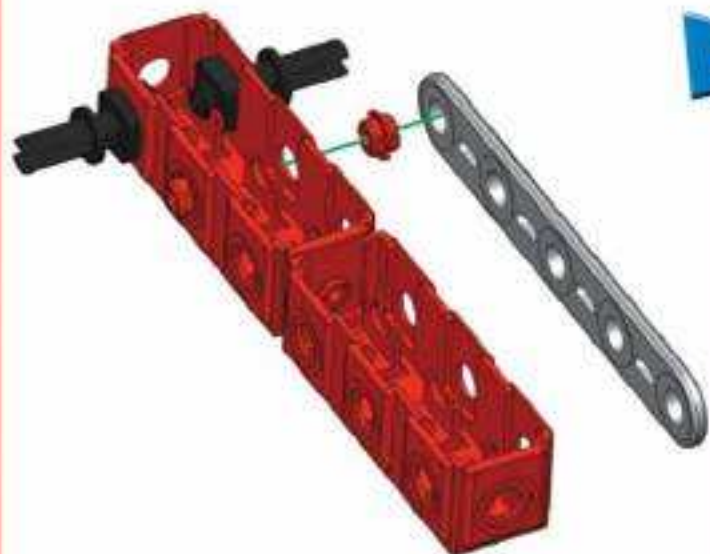

4

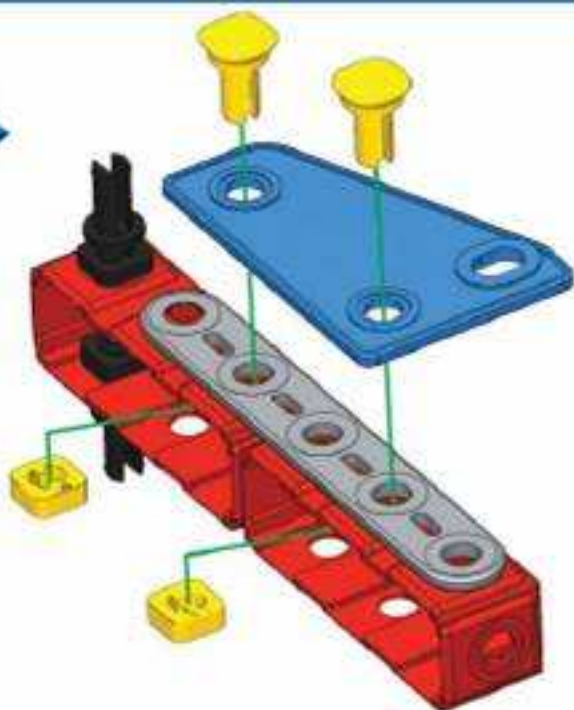

5

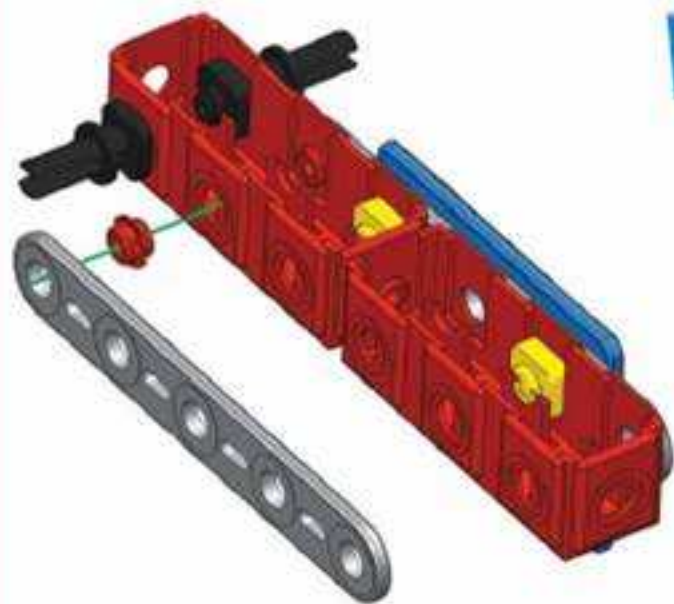

6

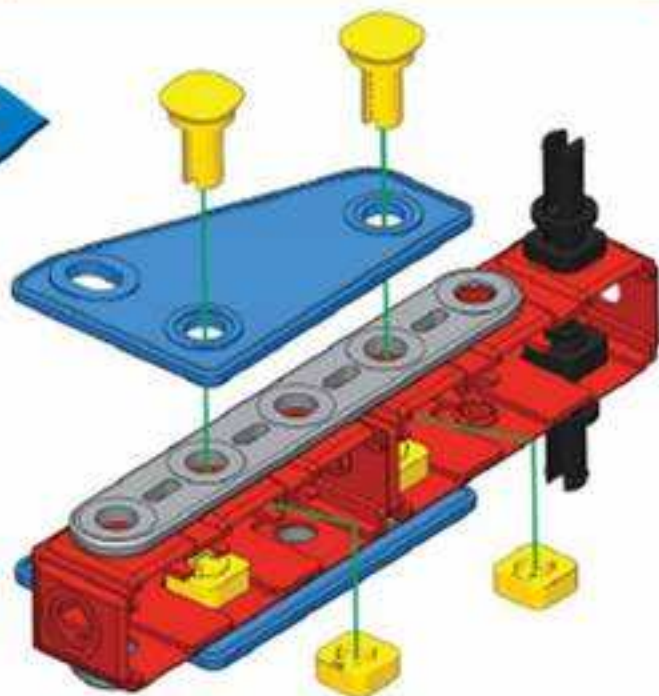

7

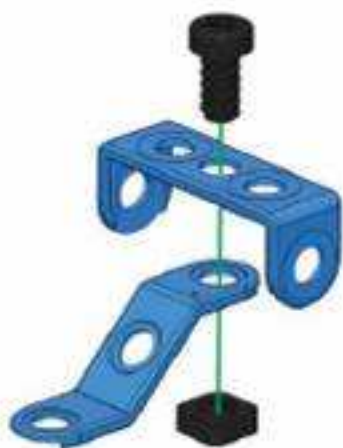

8

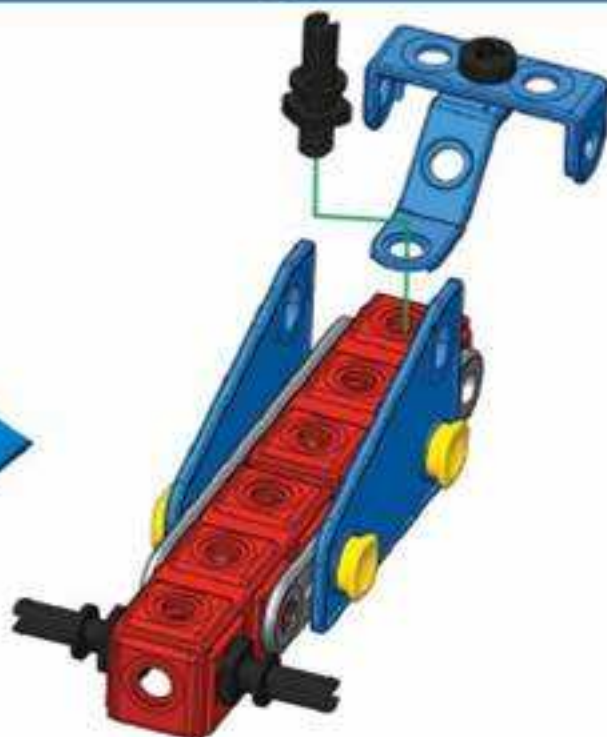

9



10

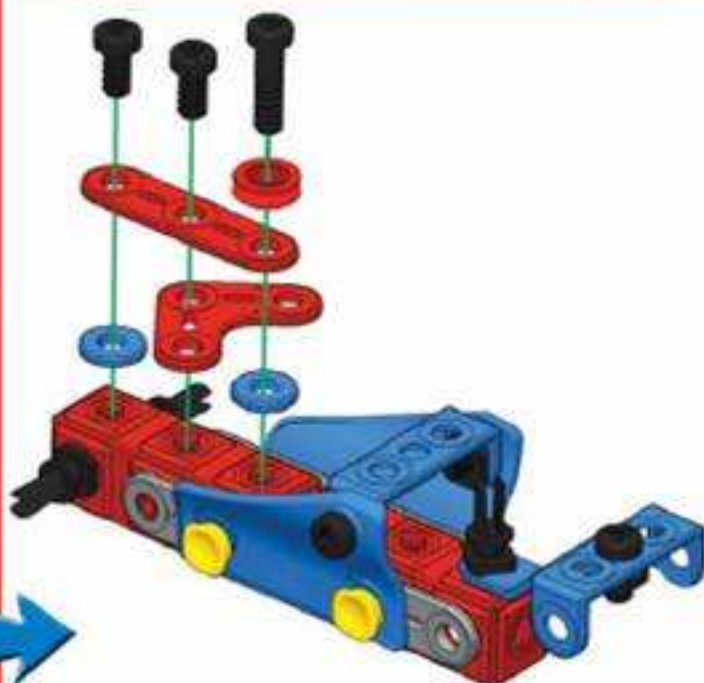

11

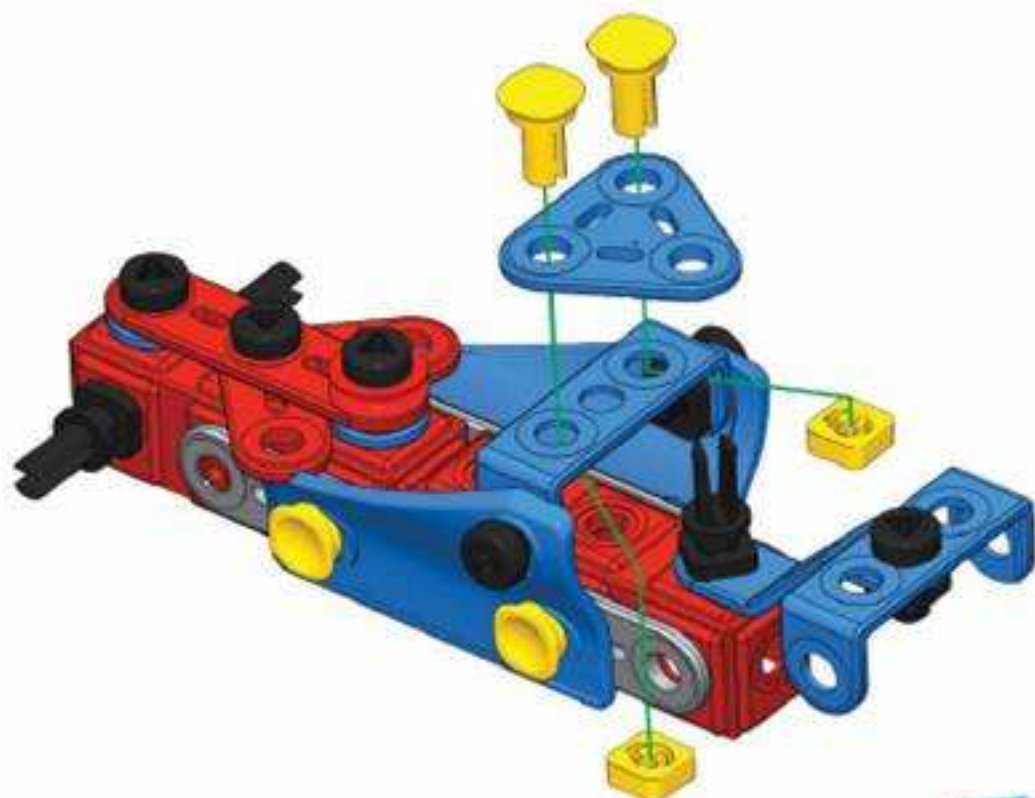

12

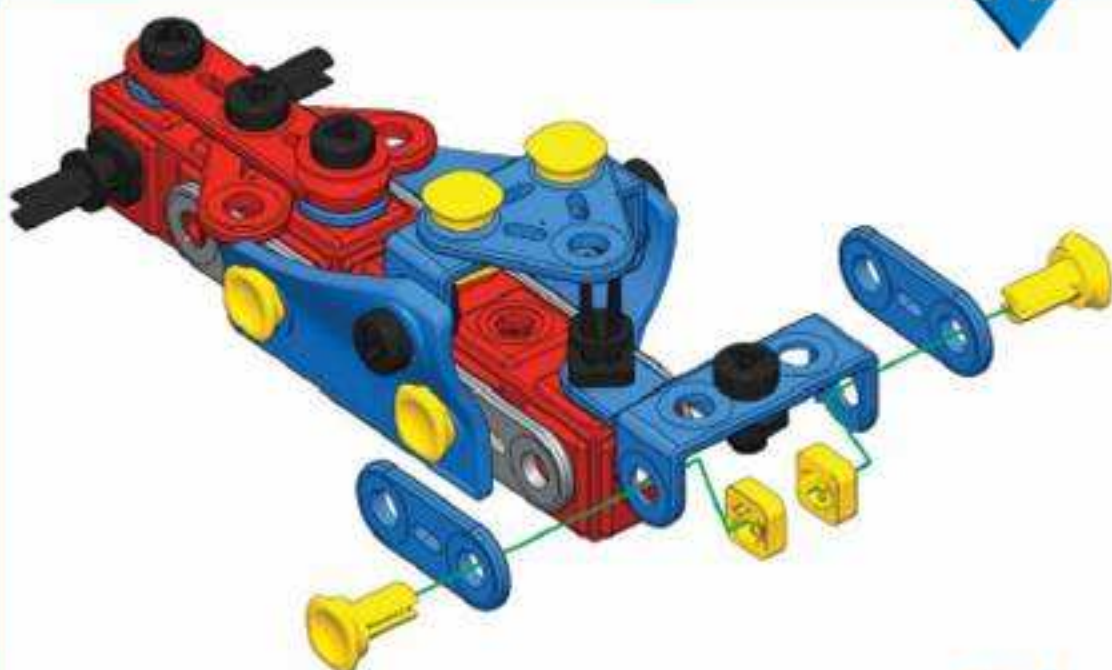
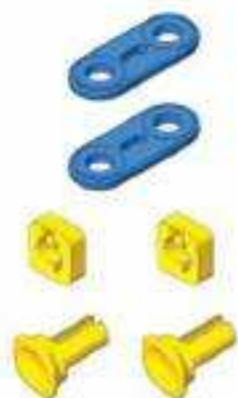

13



x4

x4



14

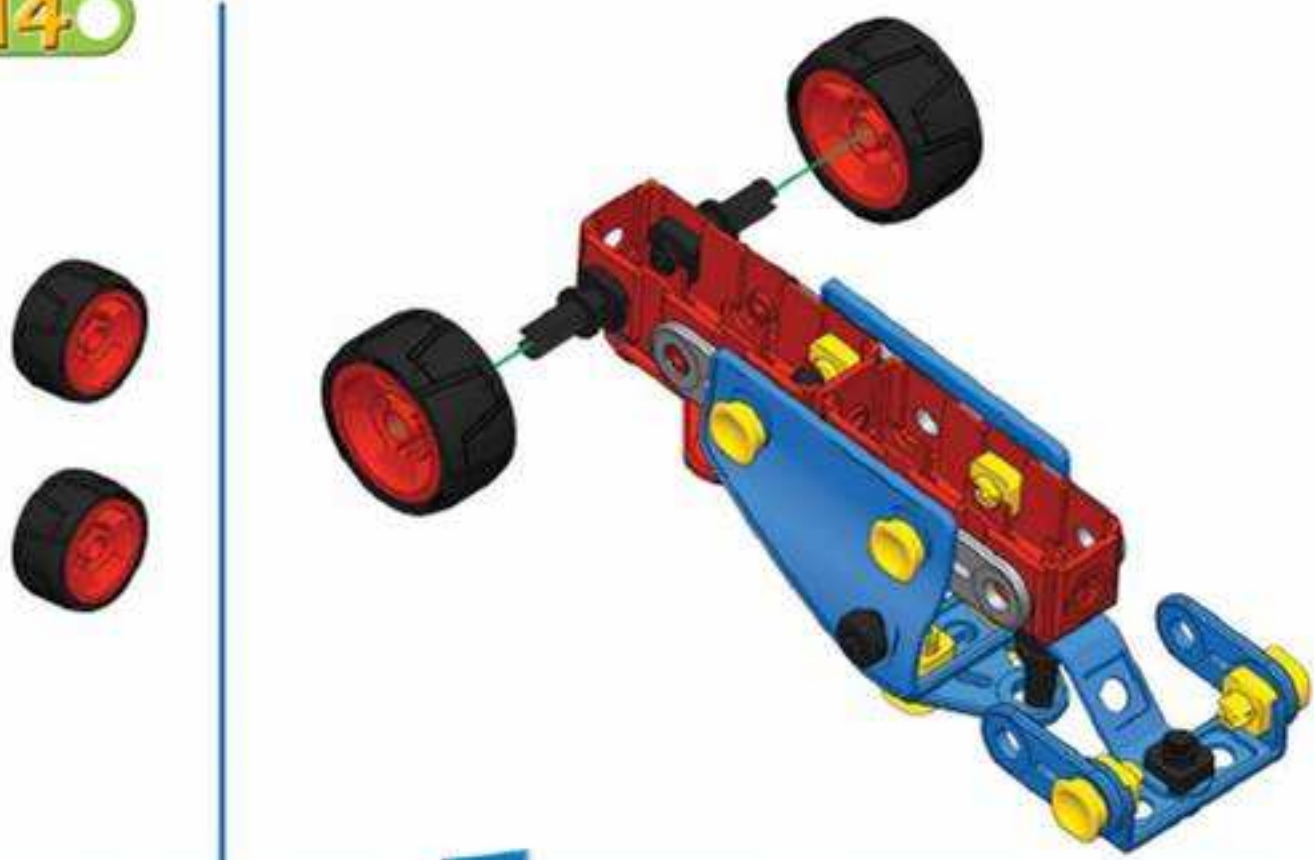

15





1

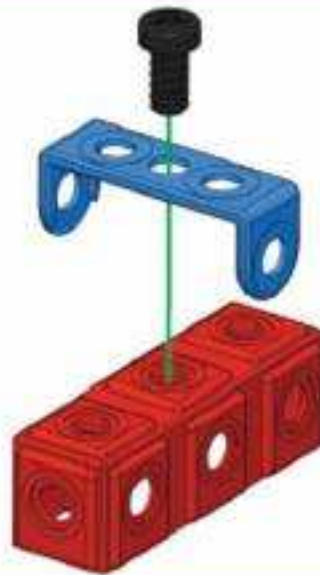
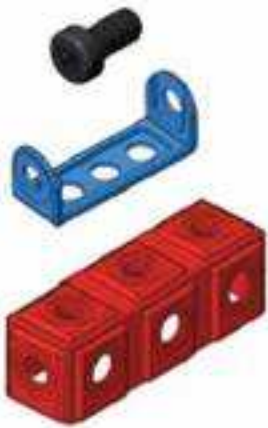

2

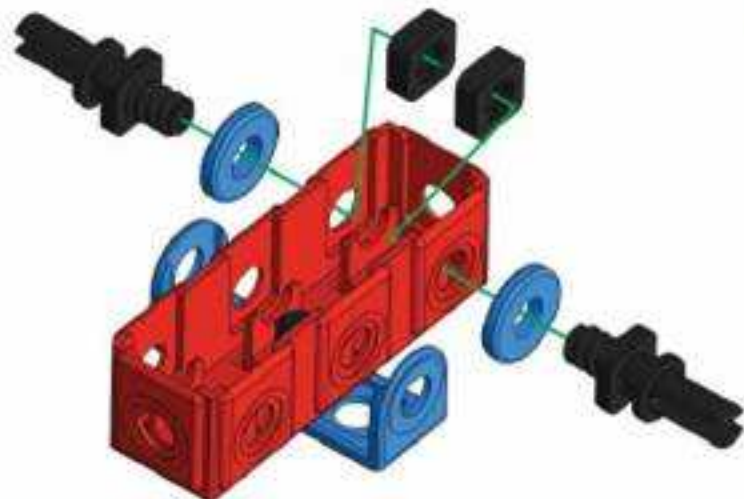

3

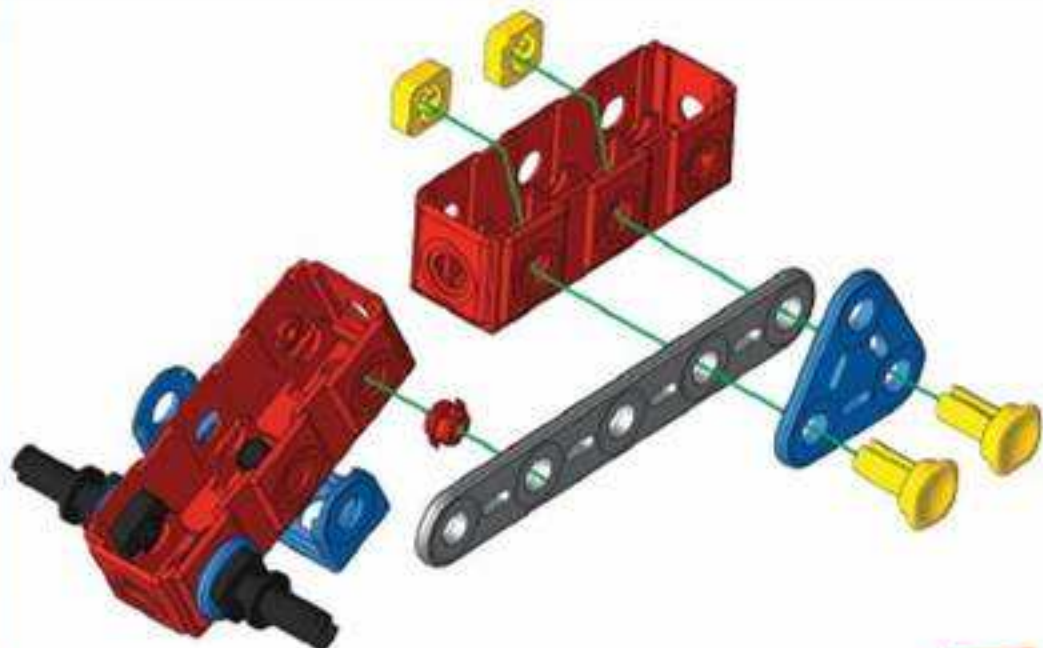
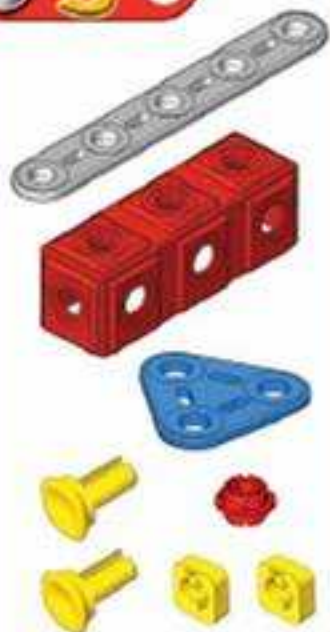

4

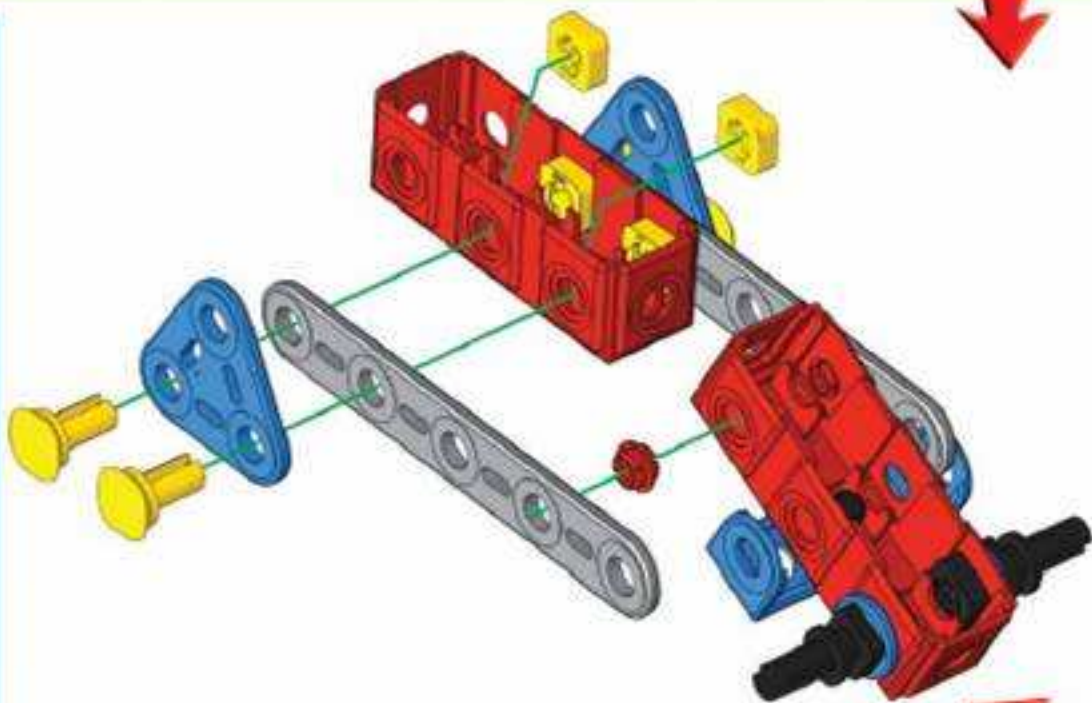

5



6

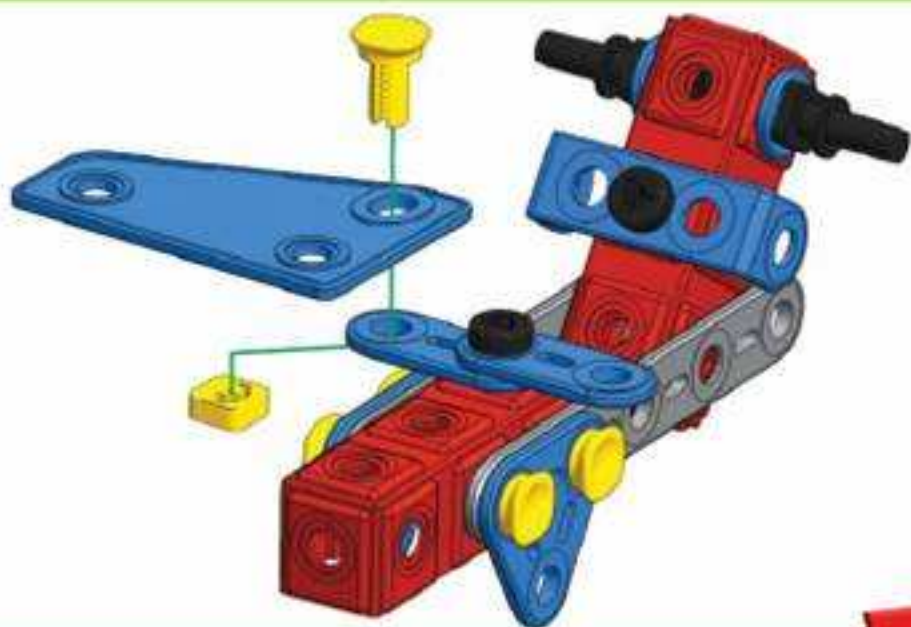

7

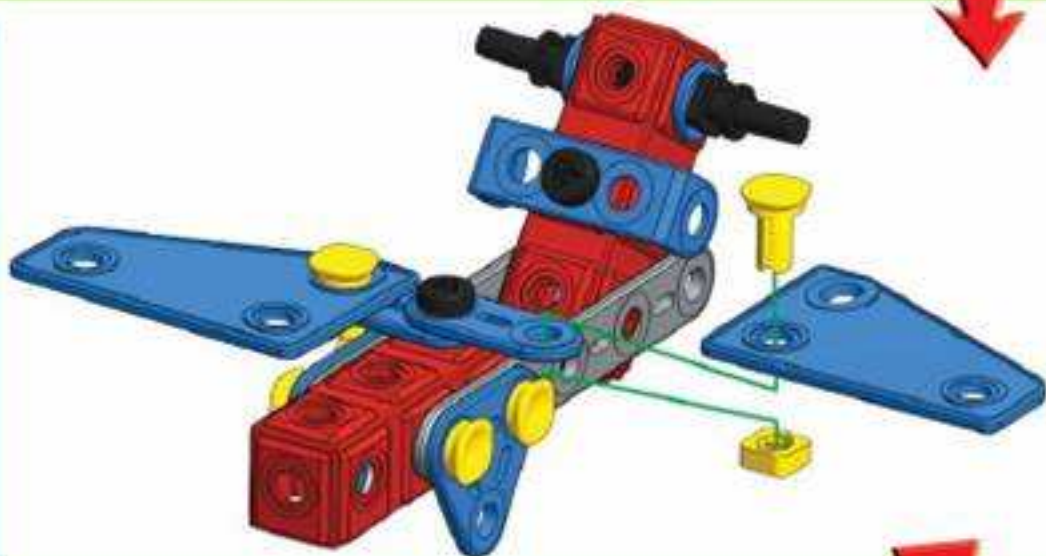

8

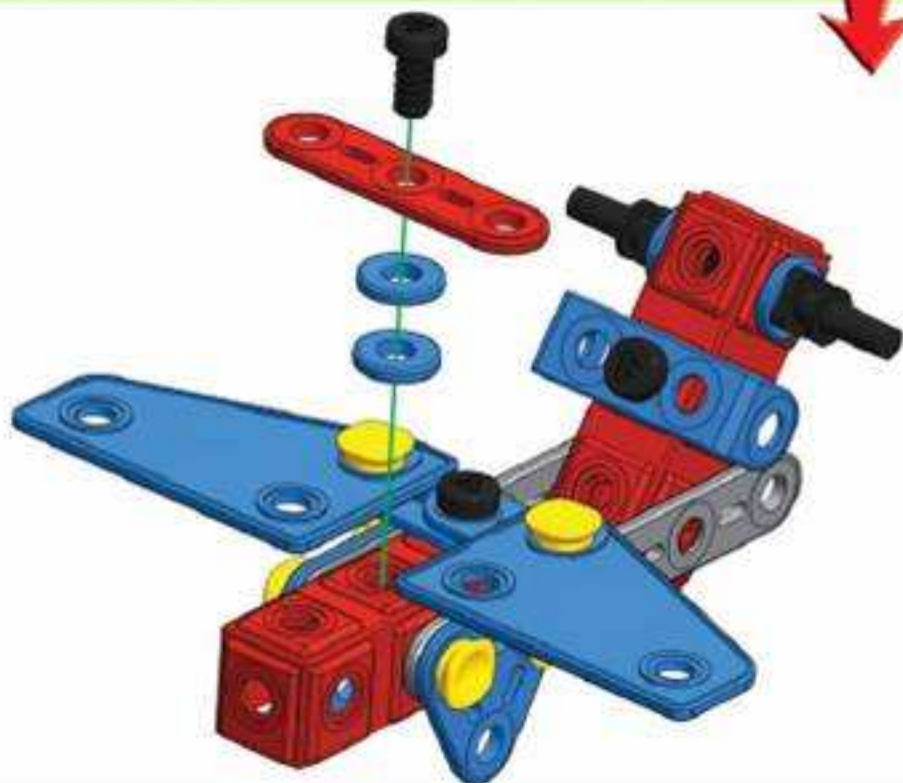

9

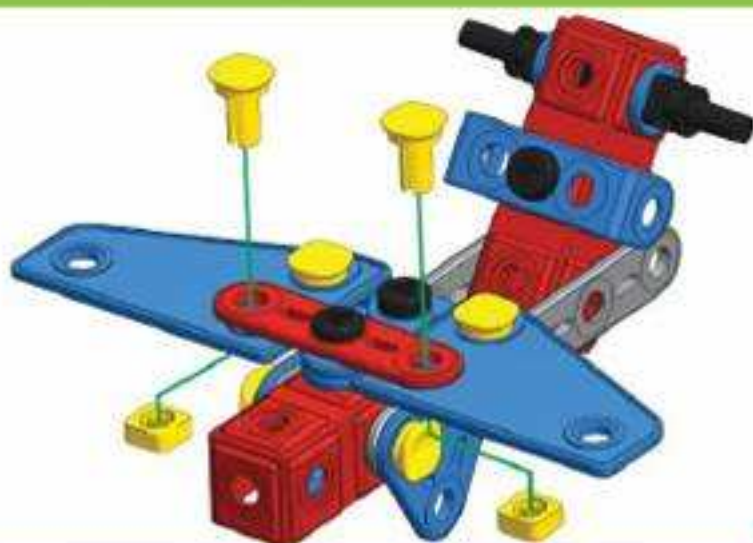

10



11



12

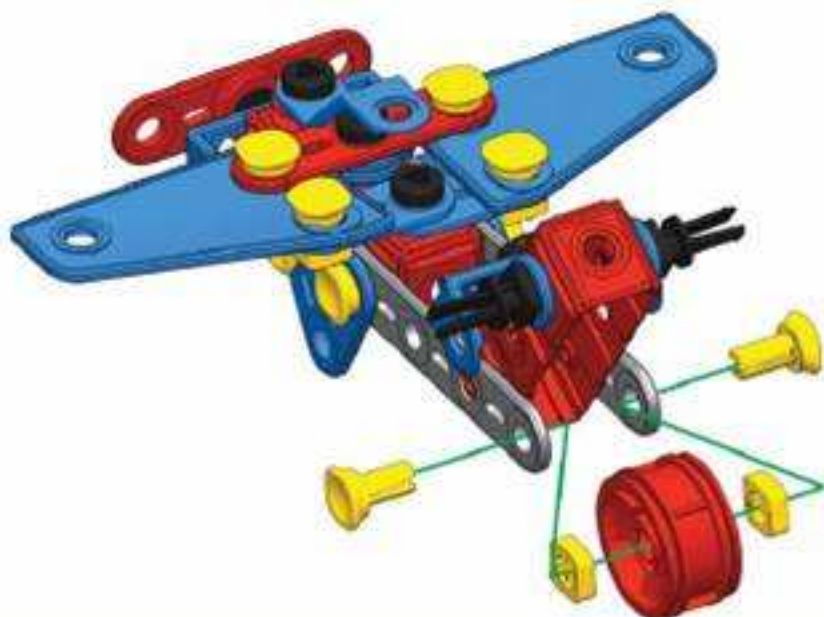

13



14

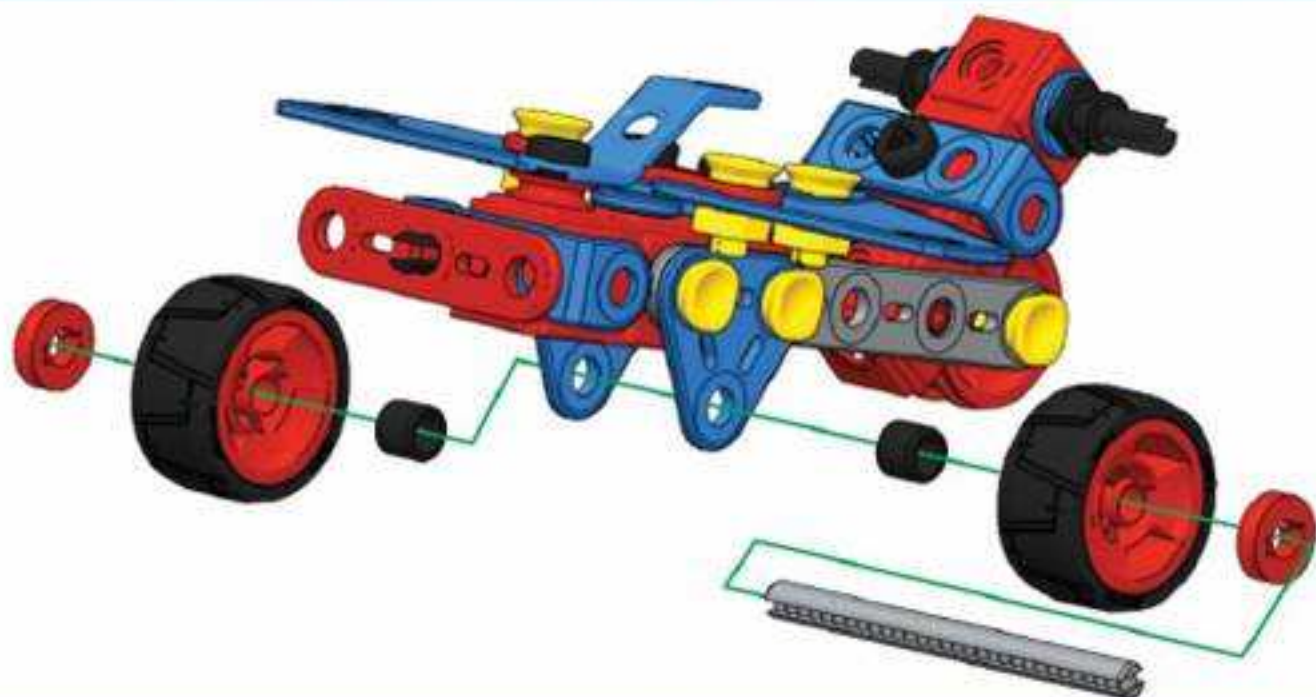



1

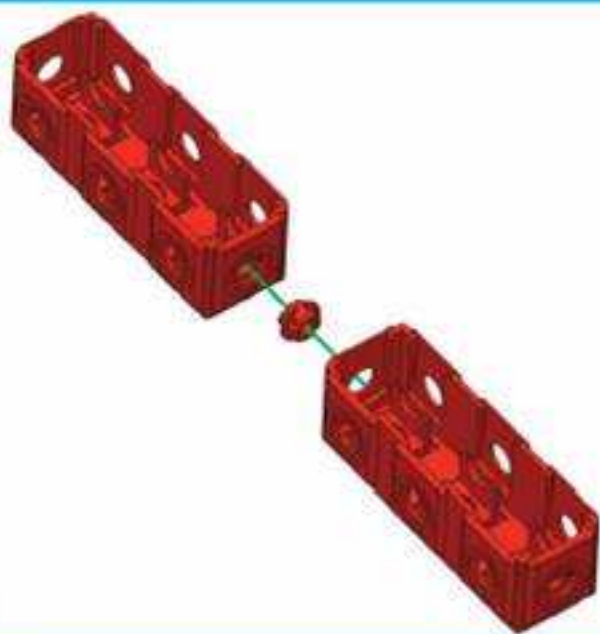
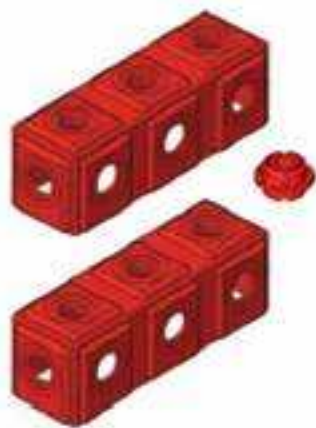

2

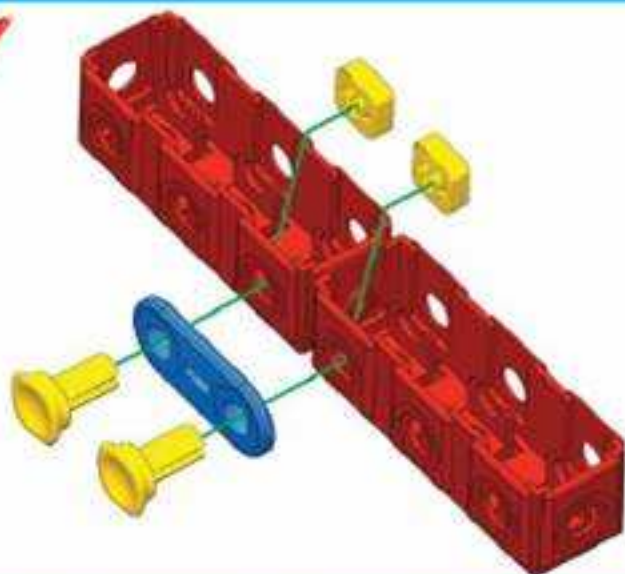

3

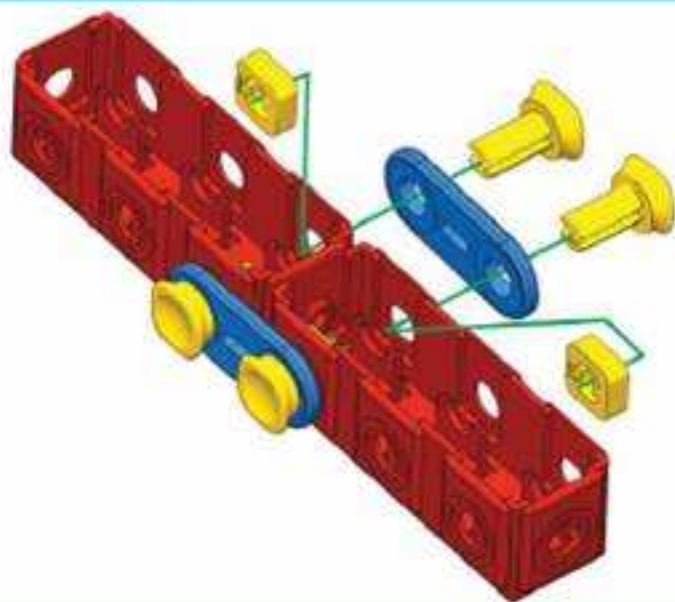

4

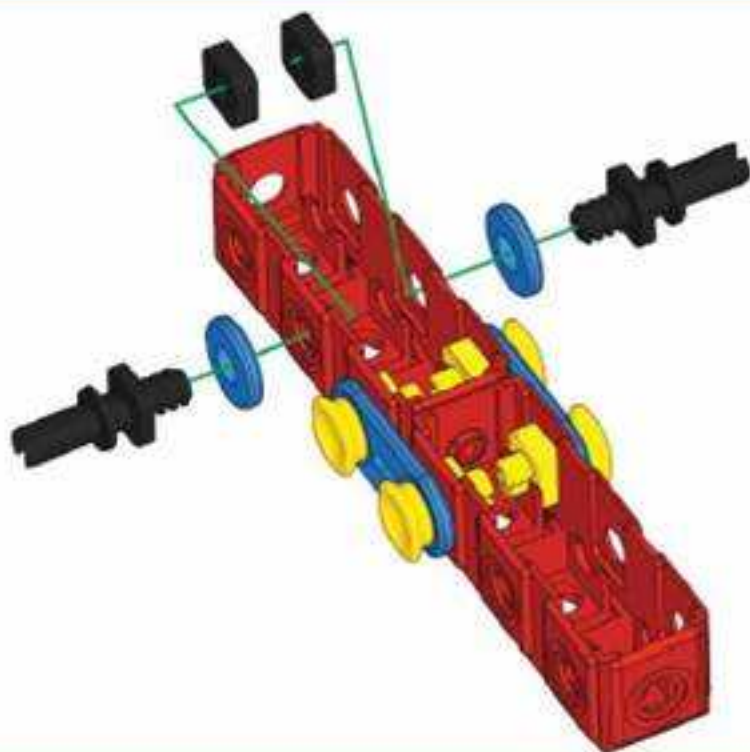

5

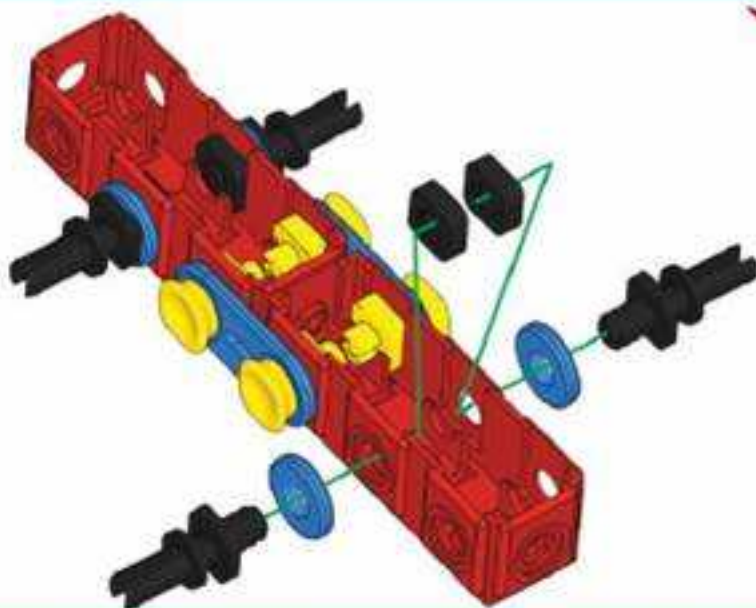

6

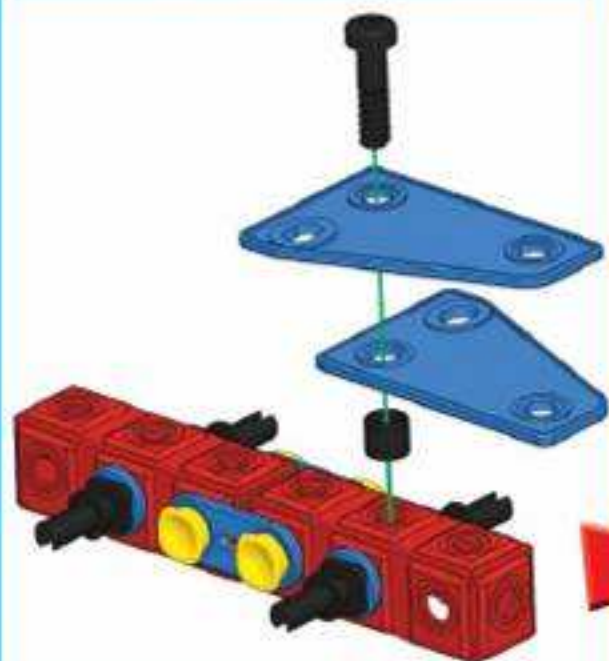

7

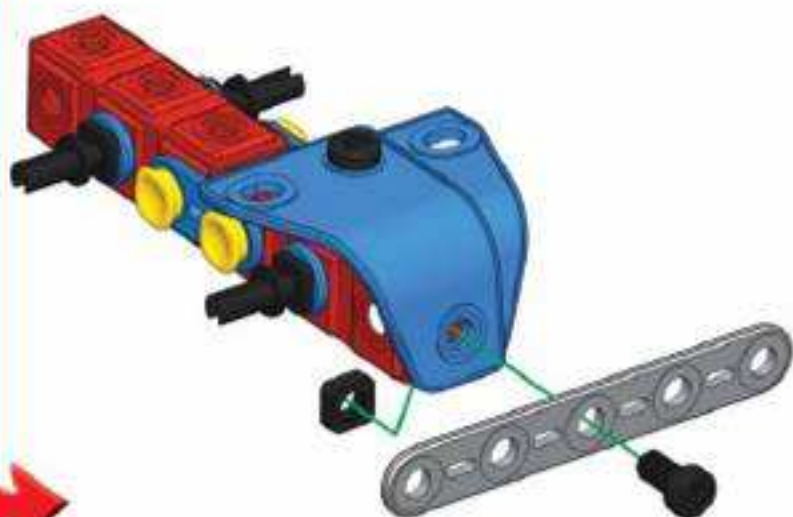

8



9

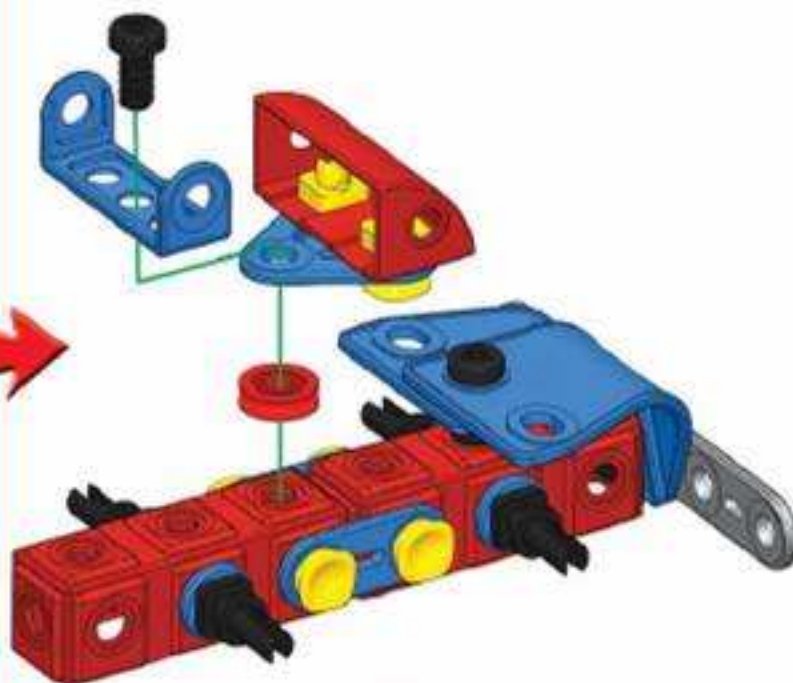

10

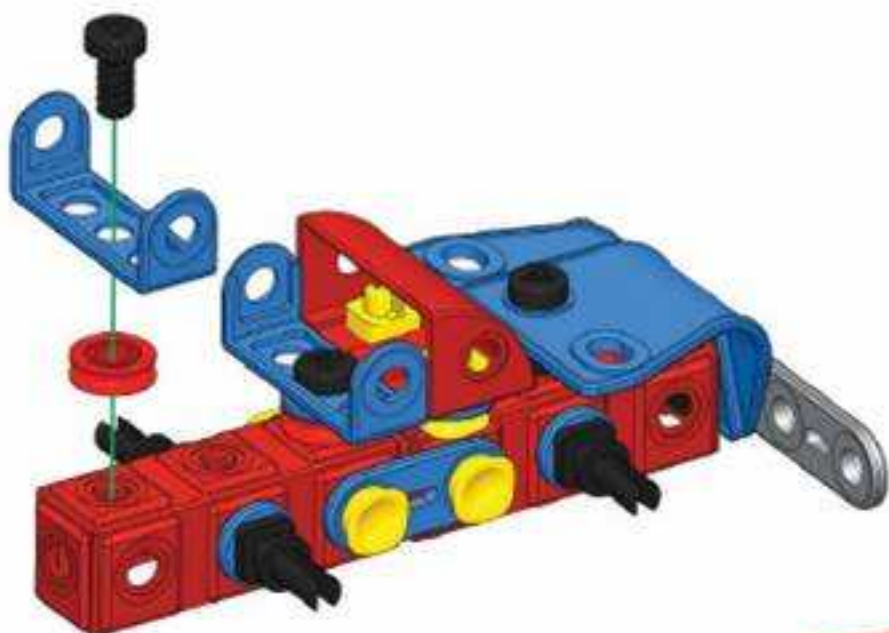

11

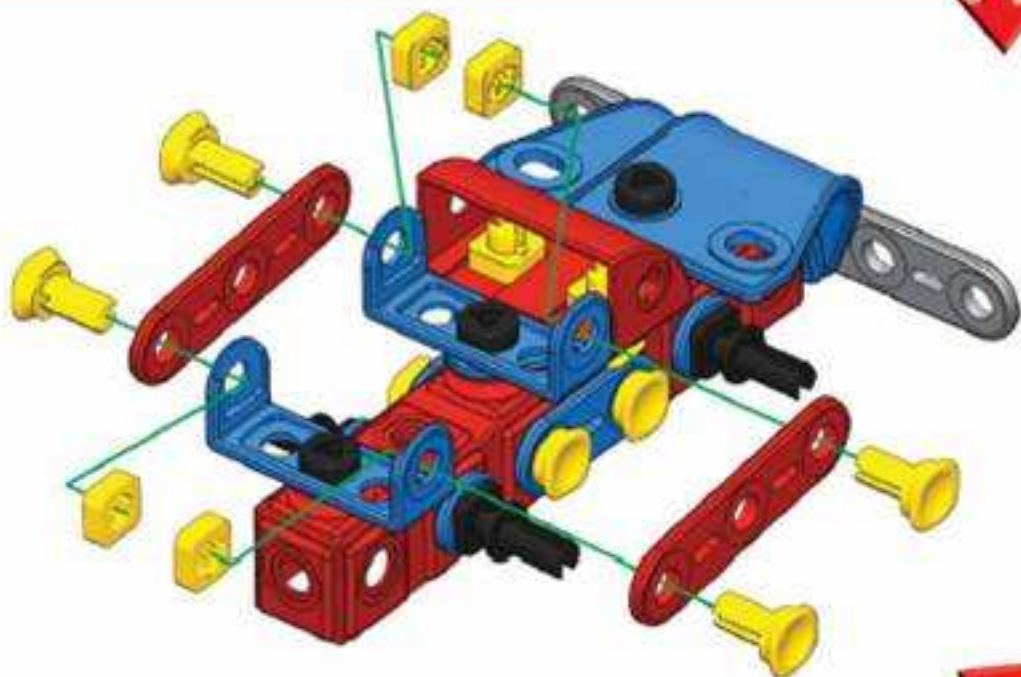

12

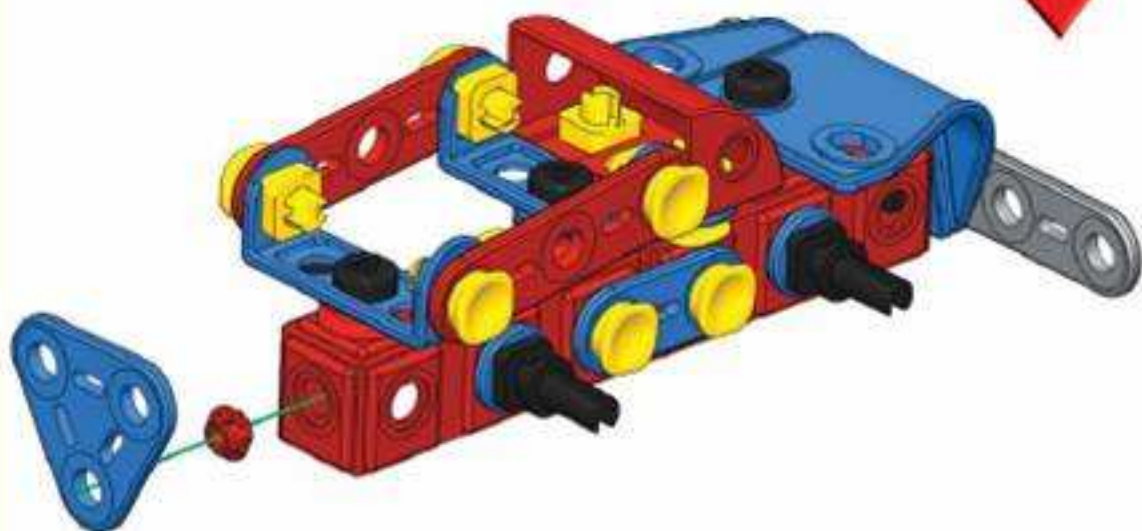

13



14

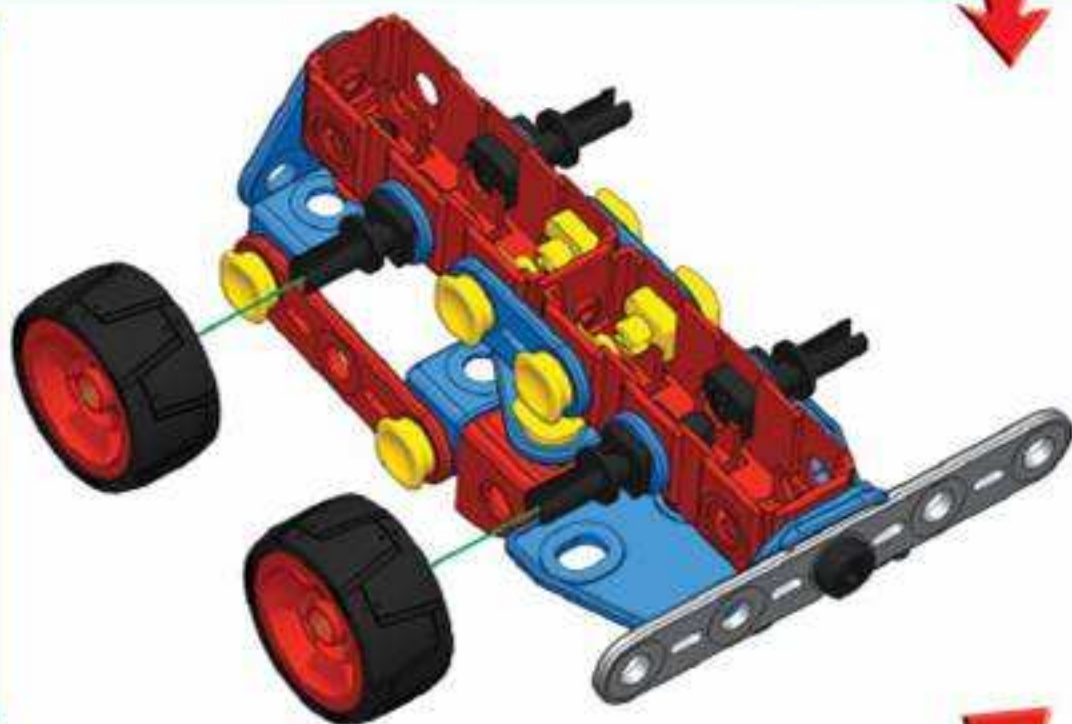

15



Warning! Attention! Achtung! Attenzione! ¡Atención! Aviso! Varning! Varoitus!
Advarsel! Waarschuwing! Προειδοποίηση! Внимание! Varovani! Tähelepanu!
[spėjimas! Figyelmeztetés! Twissija! Uwaga! Atenție! Pozor! Rabhadh! Uzmanību!



- GB/USA** Warning! Choking Hazard. Contains small parts which could be swallowed. Not suitable for children under 3 years.
- FR** Attention ! Danger d'étouffement. Contient des petites pièces pouvant être absorbées. Ne convient pas aux enfants de moins de 3 ans.
- D** Achtung! Verschluckungsgefahr. Enthält verschluckbare Kleinteile. Nicht für Kinder unter 3 Jahren geeignet.
- I** Attenzione, pericolo di soffocamento! Contiene pezzi piccoli che potrebbero essere ingoiati. Non adatto ai bambini sotto i 3 anni.
- E** ¡Atención! Riesgo de asfixia. Contiene piezas pequeñas que un niño podría tragarse. No conviene a los niños menores de 3 años.
- P** Aviso! Perigo de se engasgar. Contém peças pequenas que podem ser engolidas. Não aconselhável a crianças com menos de 3 anos.
- S** Varning! Risk för kvävning. Innehåller små delar som kan sväljas. Ej lämplig för barn under 3 års ålder.
- FIN** Varoitus! Tukehtumisvaara. Sisältää pieniä osia, jotka voidaan niellä. Ei soveltu alle 3-vuotiaille lapsille.
- DK** Advarsel! Fare for slugning. Indeholder små dele, som kan sluges. Ikke velegnet for børn under 3 år.
- NL** Waarschuwing ! Verstikkingsgevaar. Bevat kleine onderdelen die kunnen worden ingeslikt. Niet geschikt voor kinderen onder 3 jaar.
- GR** Προειδοποίηση! Κίνδυνος πνιγμού. Περιέχει μικρά εξαρτήματα που θα μπορούσαν να καταποθούν. Ακατάλληλο για παιδιά κάτω από 3 ετών.
- BULGARIAN** Внимание! Опасност от задушаване. Съдържа малки части, които могат да бъдат погълнати. Не е подходящо за деца под 3 години.
- CZECH** Varovani! Nebezpečí udušení. Obsahuje malé díly, které by mohly být spolknuty. Nevhodné pro děti do 3 let.
- ESTONIAN** Tähelepanu! Lõõbumisoht. Sisaldab väikseid osi, mida saab alla neelata. Ei sobi alla 3. aasta vanustele lastele.
- LITHUANIAN** [spėjimas! Uždušimo pavojus. Yra smulkių dalių, kurias galima nuryti. Netinka vaikams iki 3 metų.
- HUNGARIAN** Figyelmeztetés! Fulladásveszély. Apró alkatrészeket tartalmaz, amelyeket a gyermekek lenyelhetnek. 3 évesnél fiatalabb gyermekek számára nem alkalmas.
- MALTESE** Twissija! Periklu li wiehed jifga. Fih partijiet zghar li jistghu jinbelghu. Mhuwiex adattat ghal tfal iżghar minn 3 snin.
- POLISH** Uwaga! Ryzyko uduszenia. Zawiera małe części, które mogą zostać połknięte. Produkt nieodpowiedni dla dzieci poniżej 3 lat.
- ROMANIAN** Atenție! Pericol de sufocare. Conține piese mici care pot fi înghițite. Interzis copiilor sub 3 ani.
- SLOVAK** Pozor! Nebezpečnostvo udusenía. Obsahuje malé diely, ktoré je možné prehltnúť. Nie je vhodné pre deti mladšie ako 3 roky.
- SLOVENIAN** Pozor! Nevarnost zadušitve. Vsebuje majhne dele, ki jih je možno zaužiti. Ni primerno za otroke, mlajše od 3 let.
- IRISH** Rabhadh! Guais Tachta. Piosai beaga ann a fhéadhfadh a bheith insuite. Níl an bréagán seo oiriúnach do pháistí atá níos óige ná trí bhliain d'aois.
- LATVIAN** Uzmanību! Nosmakšanas draudī. Satur sīkas detaļas, kuras var tikt norītas. Nav piemērots bērniem, kas jaunāki par 3 gadiem.

USA Many of the models and component parts are unique and original designs which are the property of MECCANO. They are protected by national legislation as industrial designs, trademarks and/or copyrights throughout many countries. For detailed information, please contact: MECCANO. Meccano shall have no responsibility for (I) failure to follow instructions, (II) use of parts for any purpose other than as specified in the instructions (III) any alteration of any parts or components. MECCANO respects children's safety: all models are tested by children.

F De nombreux modèles et pièces sont des créations originales, propriétés de MECCANO et sont protégés par les législations nationales sur les dessins et modèles, marques et/ou droits d'auteurs. Pour toute information, merci de contacter : MECCANO. La responsabilité de MECCANO ne saurait être engagée en cas d'accident survenu à la suite (I) du non respect des instructions de montage (II) d'une utilisation des pièces autre que celle proposée dans la notice (III) d'une altération ou de la modification des pièces. La société MECCANO respecte la sécurité des enfants : ses modèles sont testés par des enfants.

D Zahlreiche Modelle und Teile sind Erfindungen und Eigentum der Firma MECCANO. Sie sind durch Inland-Gesetze über Zeichnungen und Modelle sowie Warenzeichen und/oder Urheberrechte geschützt. Für zusätzliche Auskünfte wenden Sie sich bitte an : MECCANO. Die Firma Meccano haftet nicht für Unfälle, die aus der (I) Nichteinhaltung der Bauanleitung, der (II) Verwendung anderer als in der Bauanleitung angegebenen Teile oder der (III) Änderung oder Modifikation der Teile resultieren. Alle Modelle der Firma Meccano wurden von Kindern getestet und entsprechen den Sicherheitsnormen.

I Numerosi modelli e pezzi sono creazioni originali della MECCANO e sono protetti dalle legislazioni nazionali sui disegni e modelli, marche e/o diritti d'autore. Per qualsiasi informazione, vogliate prendere contatto con : MECCANO. Meccano declina ogni responsabilità in caso d'incidenti sopravvenuti in seguito (I) a: non rispetto delle istruzioni di montaggio (II) utilizzo dei pezzi per funzioni diverse da quelle previste nel manuale (III) alterazione e/o modifica dei pezzi. La società MECCANO rispetta la sicurezza dei bambini : i suoi modelli vengono testati dai bambini stessi.

E Numerosas modelos y piezas son creaciones originales, propiedades de MECCANO y están protegidos por las legislaciones nacionales en la que concerne a los dibujos y modelos, marcas y/o derechos de autor. Para cualquier información, sírvase ponerse en contacto con : MECCANO. MECCANO carece de responsabilidad en caso de accidente debido a: (I) el incumplimiento de las instrucciones de montaje (II) una utilización de las piezas diferente a la que se indica en las instrucciones (III) una alteración o modificación de las piezas. La sociedad MECCANO respeta la seguridad de los niños : sus modelos están probados por niños.

P Vários modelos e peças são criações originais, propriedades da MECCANO e são protegidos pelas legislações nacionais relativas aos desenhos e modelos, às marcas e/ou aos direitos de autor. Para qualquer informação, é favor contactar : MECCANO. A Sociedade MECCANO não poderá ser responsabilizada pelos acidentes provocados: (I) pela falta de cumprimento das instruções de montagem (II) pelo uso indevido das peças ou (III) pela modificação ou alteração das peças. A Sociedade MECCANO respeita a segurança das crianças : os seus modelos foram testados por crianças.

S Många modeller och delar bildar en unik och original formgivning vilken är MECCANO egendom. Dessa modeller och delar är skyddade genom lagstiftning såsom industriell formgivning, varumärke och/eller upphovsmannarätt i ett flertal länder. För mer detaljerad information, var vänlig och kontakta MECCANO. MECCANO fräntar sig allt ansvar i händelse av olycka till följd av (I) att monteringsinstruktionerna inte har respekterats (II) en annan användning av delarna än den som står i anvisningen (III) en förvanskning eller förändring av delarna. Företaget MECCANO respekterar barnsäkerheten : modellerna har testats av barn.

FIN Useat mallit ja osat ovat MECCANO:n omaisuutta olevaa alkuperäistä suunnittelua. Ne ovat kansallisilla lailla suojattua teollista muotoilua, tavaramerkkejä ja/tai kopiointioikeuksia. Pyydämme ottamaan yhteyden MECCANO:han kaikissa asioissa liittyvissä kysymyksissä. MECCANO ei vastaa eikä kata seuraavista syistä sattuneita onnettomuuksia: (I) ohjeiden vastainen kokoaminen, (II) muiden kuin ohjeissa ehdotettujen osien käyttö, (III) osien muuntelu tai eri tarkoitukseen käyttö. MECCANO-yhtiö huolehtii lasten turvallisuudesta: lapset ovat testanneet mallimme.

DK Vore mange modeller og dele er originale fremstillinger og ejes af MECCANO Tegninger, modeller, fabrikmærker og ophavsret er lovbeskyttede i hvert land. Yderligere oplysninger kan fås hos: MECCANO. MECCANO frsiger sig ethvert ansvar, sá fremt der er sket uheld forársaget af (I) at monteringsinstruktionerne ikke er blevet overholdt, (II) at delene er blevet brugt til andre formál, end dem der er beskrevet i betjeningsvejledningen, (III) eller at delene er blevet beskadiget eller ændret. MECCANO overholder sikkerhedsreglerne for børn: Alle modeller testes af børn.

NL Veel modellen en onderdelen zijn originele ontwerpen en eigendom van MECCANO en worden beschermd door de nationale wetgevingen op tekening en modellen, merken en/of auteursrechten. Voor informatie gelieve contact op te nemen met MECCANO. De verantwoordelijkheid van MECCANO is uitgesloten in geval van ongevallen voortkomend uit het niet naleven van de montage-instructies (I), uit het gebruik van andere onderdelen dan die zoals vermeld in de handleiding (II) of uit het veranderen of modificeren van de onderdelen (III). De firma MECCANO neemt de veiligheid van de kinderen in acht : de modellen zijn door kinderen getest.

GR Πολλά μοντέλα και ανταλλακτικά είναι αυθεντικά, ιδιοκτησία της MECCANO και προστατεύονται από τις εθνικές νομοθεσίες για τα μοντέλα της μάρκας ή τα διπλώματα ευρεσιτεχνίας. Για κάθε πληροφορία παρακαλώ απευθυνθείτε στη MECCANO, ή ευθεία της MECCANO. Δεν διασφαλίζεται σε περίπτωση ατυχήματος που έγινε συνεχώς (I) μη σεβασμού των οδηγιών συναρμολόγησης (II) χρήσης των τεμαχίων διαφορετική από αυτήν που προτείνεται στις οδηγίες (III) καταστροφή ή αλλαγή των τεμαχίων. Η εταιρεία MECCANO σέβεται την ασφάλεια των παιδιών: τα μοντέλα της δοκιμάζονται από παιδιά.

MECCANO

363, avenue de Saint Exupéry
62100 Calais - France
<http://www.meccano.com>
<http://www.erektor-sels.com>
© 09/2011 MECCANO

®MECCANO and ERECTOR are exclusive trademarks of MECCANO
All rights reserved

CE

760302 104 111W

